

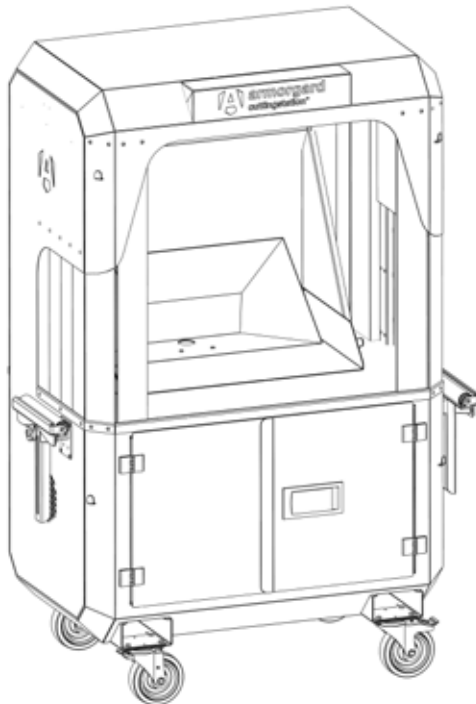

cuttingstationTM

Operational and maintenance manual

Suitable for: SS7-T



1-877-794-2848 >> info@armorgardusa.com



Welcome

Welcome to the Armorgard CuttingStation. A mobile unit that was designed to help contain noise, dust and increase safety while cutting. Please consult this manual for instructions on how to get the most from the unit.

Please read this operational and maintenance manual carefully prior to using your CuttingStation. Always keep this manual with the product and read prior to use.

Contents

Safety information.....	4
Product specification.....	5
What's included.....	6
Tools you'll need.....	8
Getting to know your CuttingStation.....	9
Padlock housing dimensions.....	10
Electrical safety information.....	11
How to use the lock.....	12
How to assemble.....	14
Installing the casters.....	15
Installing the support arms.....	16
Attaching the power strip.....	18
Attaching the light.....	19
How to use the dust collector.....	20
How to use the support arms.....	21
How to extend the cutting space.....	22
Optional extras.....	23
Installing the crane lifting eye kit (optional extra).....	24
Storing the unit.....	25
Transporting the unit.....	26
Equipment care & ongoing maintenance.....	27
Warranty.....	26
Spare parts.....	30
Notes.....	31



Safety information

- » Before using the CuttingStation, ensure any relevant risk assessments are carried out. Armorgard cannot be responsible for accidents that occur due to negligence. Cordon off a clear area when operating the CuttingStation determined by a site risk assessment.
- » Before using the CuttingStation, check against relevant OSHA guidelines.
- » Always ensure the CuttingStation is not damaged before using it.
- » Always lock the unit when not in use or unattended. Do not leave keys inside the unit while locking.
- » Before using the CuttingStation, you must lock the casters. Only position the CuttingStation on stable and even ground to prevent it rolling over and causing injury or personal harm. Ensure caster is locked when it's not being moved.
- » You must close the doors while the unit is in motion to prevent damage to contents and the product, and ensure support arms are secured in place. When transporting, the doors must be locked shut and the product securely fastened to the vehicle.
- » Any alteration to or unintended use of this product could create a danger of an explosion or other hazardous conditions that can result in serious personal injury, property damage or even death.
- » Always wear the appropriate PPE for the task you are performing, as outlined in your risk assessment or safe work practices.
- » Before servicing or making any adjustments, always disconnect power and secure any equipment safely.
- » Relevant fire extinguishers must be nearby while the CuttingStation is in use. Four hooks are provided on the CuttingStation to mount the extinguisher.
- » Take care when moving the rear panel, material support arms and door latches as they can present a finger trap hazard.
- » Only use in well lit areas.
- » Ensure weight is evenly distributed and heavier items are ALWAYS loaded in the base.

-
- » The unit has an overall WLL of 1000 lbs.
 - » Do not exceed roller capacity of 100 lbs.
 - » This product should not be used for transporting or storing explosives, hazardous wastes, flammables or hazardous materials such as gas tanks, containers of solvents, dynamite, gunpowder, etc.
 - » Only use UL or CSA listed electrical devices that meet the requirements of the local jurisdiction.
 - » You may require a forklift or pallet truck when unloading your CuttingStation.

While every effort has been made to ensure this operational and maintenance manual covers every aspect needed to operate your product safely, please take care while using the product and always operate with caution. Always liaise with management personnel on site for any additional operational restrictions that you need to be aware of.

Do	Don't
✓ Carry out risk assessments	✗ Misuse the CuttingStation
✓ Keep fire extinguishers nearby	✗ Leave keys inside unit when locking
✓ Operate on a flat, even surface	✗ Leave trailing cables from unit
✓ Apply brakes while cutting	✗ Leave unlocked when unattended

Product specification

Product code	Description	Weight (lbs)	External dimensions W x D x H (inches)	Internal dimensions W x D x H (inches)
SS7-T	CuttingStation	396	54.7 x 30.7 x 75	44.3 x 28.3 x 22

CuttingStation™ Patent 17183824.6

Design Registration 004511525



What's included...



1x CuttingStation



1x caster kit



1x light



2 x support arm housing



2 x galvanised support arms



2 x material support T-piece



2 x material support V-piece



2 x material rollers



8x M6 bolts and M6 nyloc nuts (for support arm housings)



4x handle wheel star screws

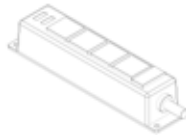

1x power strip



1x rubber mat



1x rubber grommet



Tools you'll need...



2x adjustable wrench or ratchet and socket set (to add casters and support arm housing)



Drill and 13/32" or 10.5mm drill bit (to add optional crane lifting eyes)



Screwdriver (for attaching power strip)

Getting to know your cuttingstation™

Your new, instant cutting room, revolutionizing safe cutting on jobsites

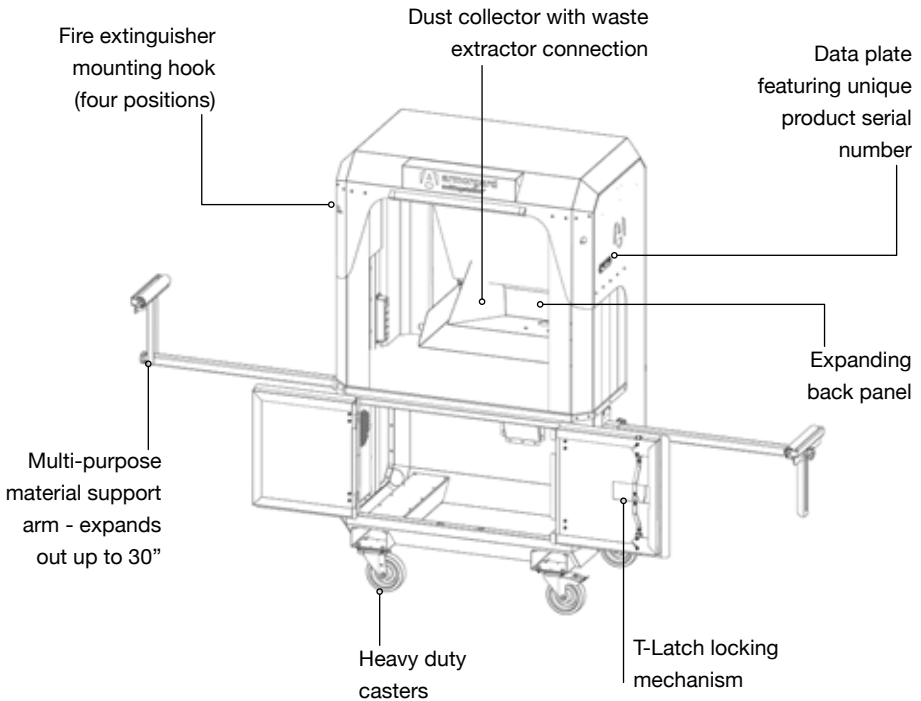

T-Latch Lock



Forklift pockets



Heavy-duty casters



Cable pass through point



Suitable for use on-site



Padlock housing dimensions

This lock system is designed to be used with a Master Lock No. 1, Master Lock No. 5, ABUS 41/50 or American Lock No. 50, or an equivalent sized lock. If you are using a padlock not listed above, it is your responsibility to make sure the lock mechanism is working correctly. Padlocks must meet ALL requirements listed in diagram.

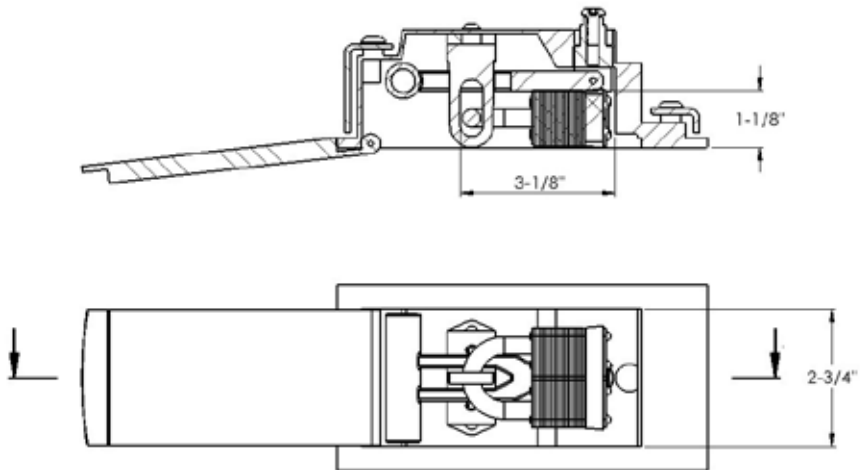

Padlock not included

Electrical safety information

All electrical work MUST be performed properly with safety precautions. To prevent injury or damage to property, please ensure the below information is read carefully. Only use UL or CSA listed electrical devices that meet the requirements of the local jurisdiction.

Extension cords

- » Ensure that manufacturer's instructions and safety information are always followed.
- » Never use a damaged cord. Always check before using.
- » Always insert cords after the rubber grommet is safely in place.
- » You must not overload the extension cord.
- » You must only use cords that are designed for outdoor use.
- » Prior to transporting the unit, ensure all cords have been removed from the grommet.
- » Extension cords must not be connected to outlet that also supplies critical safety equipment.
- » Always use UL or CSA certified products/accessories.

Cordless battery chargers

- » Ensure that manufacturer's instructions and safety information are always followed. Chargers and batteries must be cared for properly following manufacturer's guidelines.
- » Place electrical components on shelf (if applicable).
- » If electrical components become wet or exposed to hazardous and flammable substances, switch off and discontinue use immediately.
- » Always check chargers and batteries will operate properly and are not damaged.
- » Do NOT come into contact with metal prongs when plugging or unplugging electrical components.
- » Electrical components must be kept away from flammable and hazardous substances.
- » Only place suitable jobsite equipment in the unit.



>>
Video: how to use
T-Latch Lock

How to use the lock

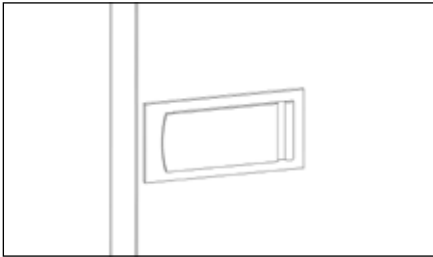

- 1.** To open the unit, locate the lock housing at the center of the door. Open the cover plate to expose the locking mechanism.

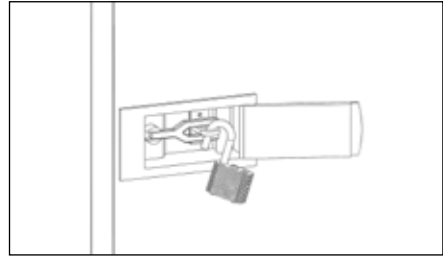

- 2.** Unlock the padlock and remove it.

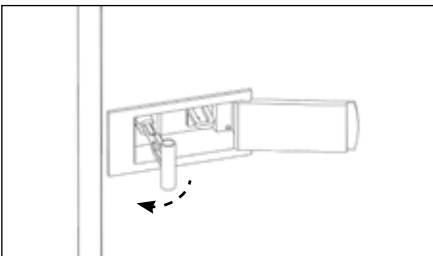

- 3.** Grab the T Handle and swing it to the left until it's perpendicular to the front face of the door.

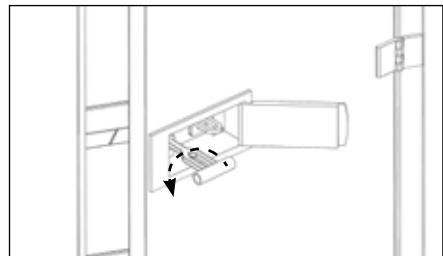

- 4.** Twist the handle 90° to release the door and pull to open it.

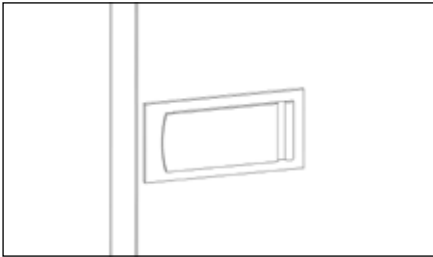

- 5.** To lock the unit, shut the door, then open the cover plate to expose the locking mechanism. Ensure doors are fully closed properly at top and bottom of the door.

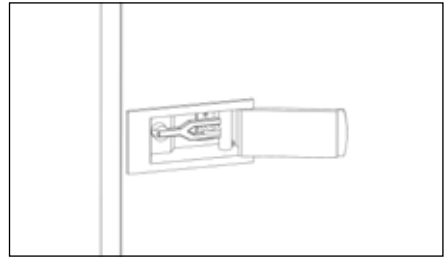

- 6.** Close the T-Handle back through the loop. Ensure the T Handle is parallel to the front face of the door.

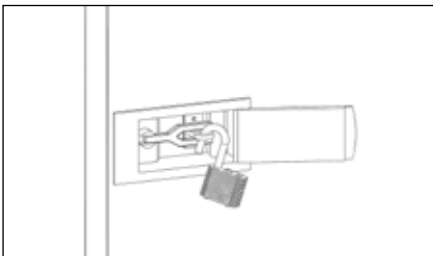

- 7.** Slide an unlocked padlock into the inner shackle of the pocket to prevent the movement of the T Handle.

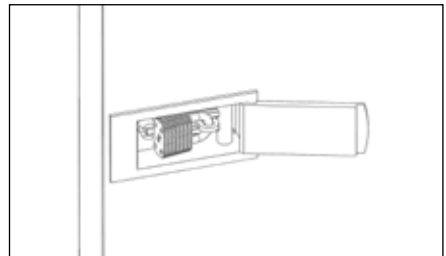

- 8.** Lock the padlock, and fit it into the lock housing. After removing the key, the cover plate should be able to close easily.



How to assemble

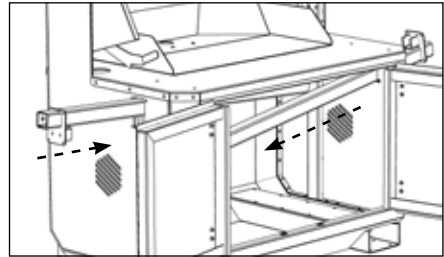
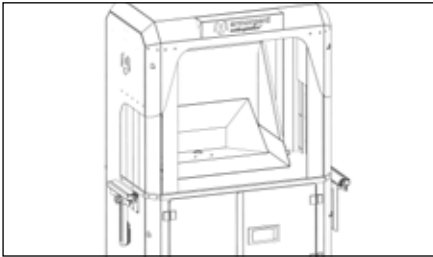

- 1.** It is important to check that the product is not damaged upon arrival and all parts are intact and everything is included - see page 6 for contents.

- 2.** You will need to install the support arm housings to the unit using the support arm fixings provided. Firstly, from the outside, feed in the arm housings so they are hanging down inside the unit. They should be opposing orientation.

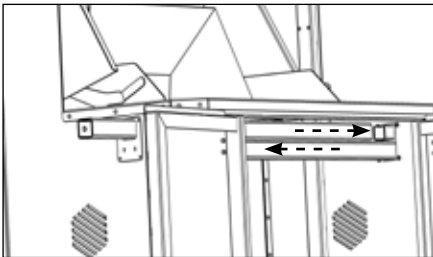

- 3.** Now from the inside, slide the arm housings together coupling the box section into the U channel at each end to form a bridge.

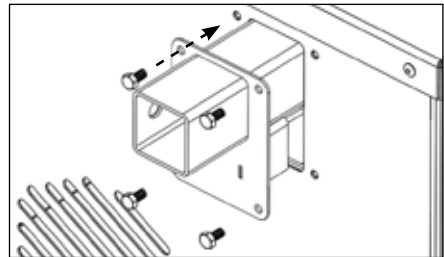

- 4.** Now that the support arms are horizontal and self supporting, whilst standing over the unit, feed the bolts from the outside into the nuts inside the unit (the bolts will be tight through the holes).



>>
Video: how to attach
the casters

Installing the casters

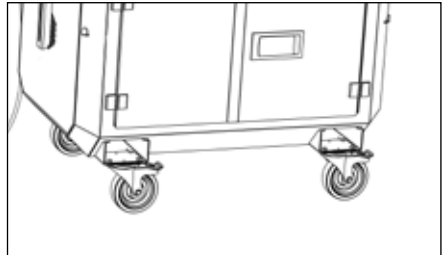
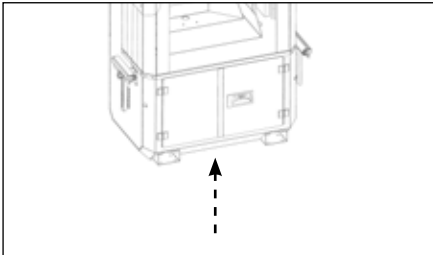

- 1.** Lift the CuttingStation onto a stable platform to ensure it does not roll and cause injury. The unit **MUST** be empty when installing casters.
- 2.** Two of the casters are swivel braked. We recommend fitting the braked casters at the front of the unit.

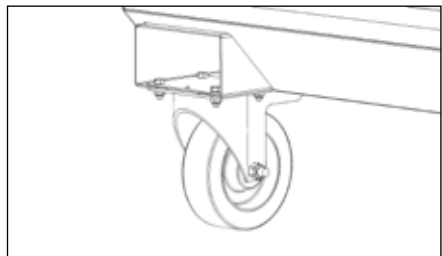
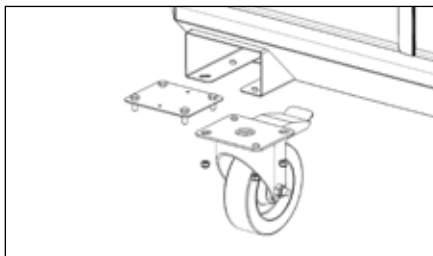

- 3.** Insert the caster plate and tighten the nuts from the bottom using the adjustable wrench.
- 4.** Repeat step three for the other wheels. Once complete, check all nuts are tight, and then ensure the casters can swivel through 360° before lowering the CuttingStation.



>>
Video: how to install
support arms

Installing the support arms

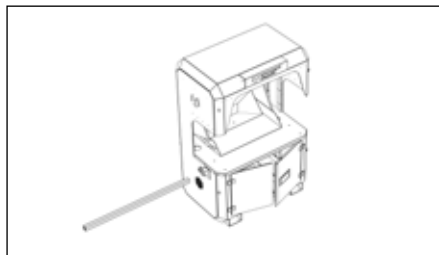

- 1.** Take one of the support arms and insert into the side tube located on the body of the CuttingStation. Before the support can be installed, the inner support sections must be installed - see page 12 on how to do this.

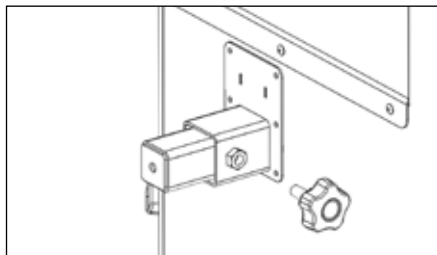

- 2.** Screw in one of the star screws on the rear of the tube part. This will prevent movement from the arm and make it adjustable.



- 3.** To assemble material support, feed one end of roller through the hole of the T-piece, then push through other sprung loaded end until it is in place. Repeat to locate V-piece ensuring it's facing the correct direction. It should be fixed in the orientation as shown.

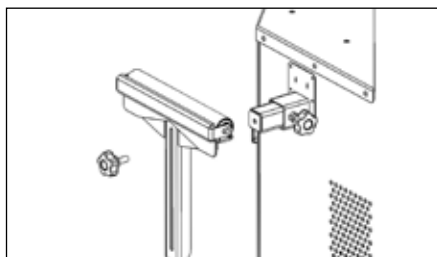

- 4.** Next, take one of the rollers and align its vertical slot with the hole. Use another star screw to secure the roller in place on the end of the support arm.

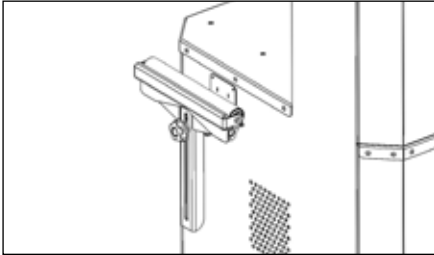

- 5.** Finally, repeat steps to install the remaining support arm on the other side of the unit. Ensure the arms are attached tightly before use.



>>
Video: how to attach
power strip

Attaching the power strip

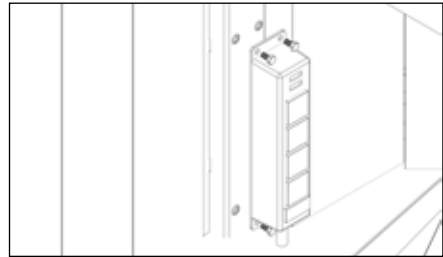
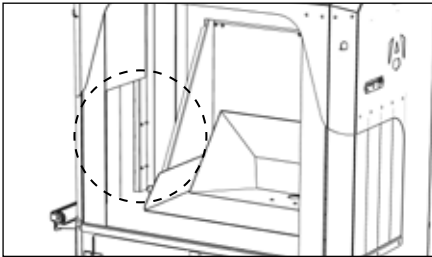

1. Locate the pre-drilled holes to fit the power strip inside on the left of the CuttingStation.

2. Take the strip and align the unit holes with the ones in the plates. Insert the bolts and tighten with the wrench. Be sure to position the power bar with the cord facing down.

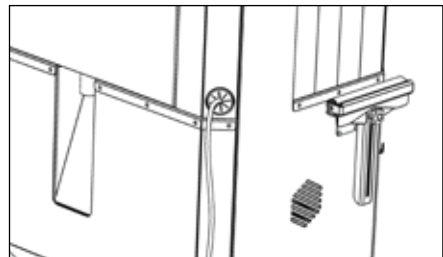
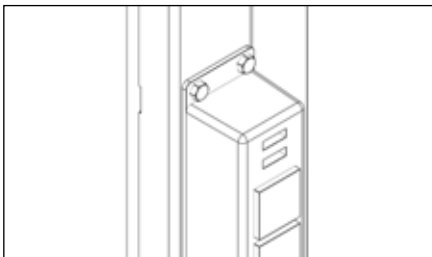

3. Ensure the strip is fitted on tightly before using it. Cover the power strip when not in use.

4. Ensure the cable is trailing away from any hazards and exits the CuttingStation through the rubber grommet at the rear. Never use in wet conditions.

Attaching the light

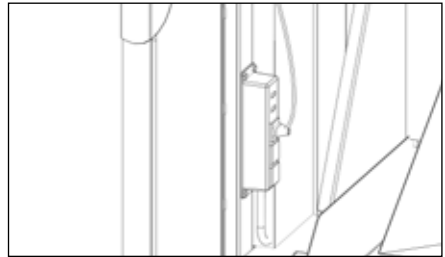
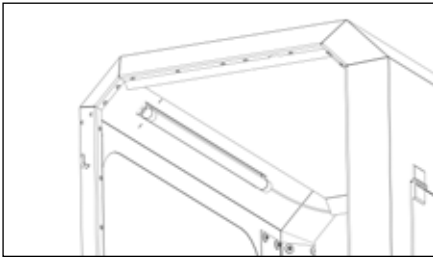

1. Use the magnetic light to position in correct location of the unit.

2. This can be plugged into the power strip provided.

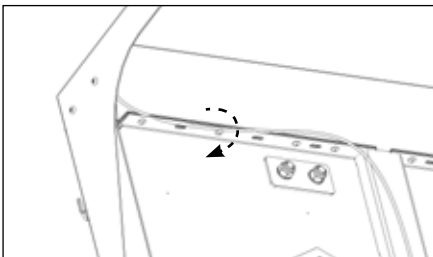

3. Use zip ties to ensure cable doesn't interfere within the working area.



How to use the dust collector

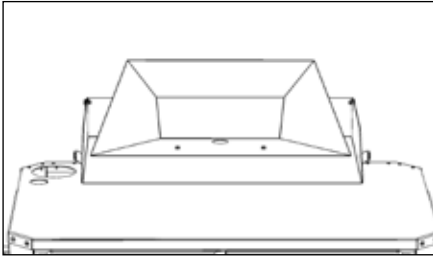

- 1.** Dust/debris/waste can be collected using the hopper. Always place chute above a metal bin or suitable collection container for sparks cutting.

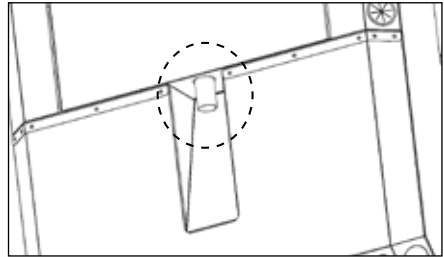

- 2.** Debris can be collected in a bucket placed beneath the chute at the rear of the CuttingStation. Alternatively, a suitable dust extractor or bag can be attached to the 2" tube.

if attaching a dust extractor or vacuum, it is the responsibility of the user to ensure it is suitable for the materials that are being cut inside the CuttingStation.



>>
Video: how to use
the support arms

How to use the support arms

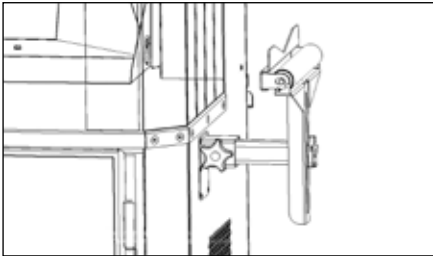

1. The two star screws on the support arm can be loosened to allow the support arm to slide in and out, and up and down.

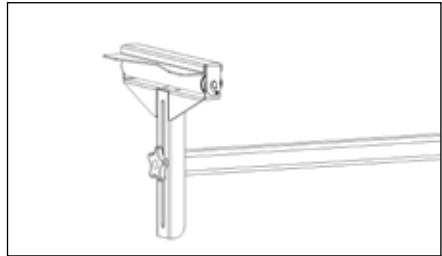

2. The support arm can be configured to have a flat support rest. We do not recommend extending the arms further than 30" from the main unit.

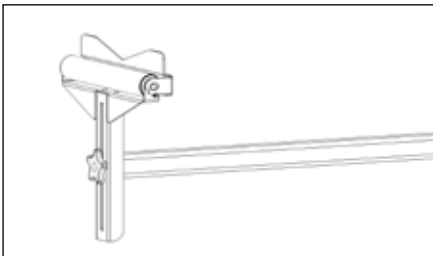

3. The support arm head can be turned 90 degrees for a v-shaped support to hold round materials. Note that in this position the flat surface can also be used as a stop for efficient cutting.

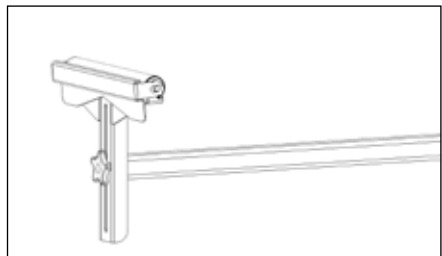

4. The last configuration is a roller, to enable materials to be repositioned easily while being supported at the same time.



>>
Video: how to extend cutting space

How to extend the cutting space

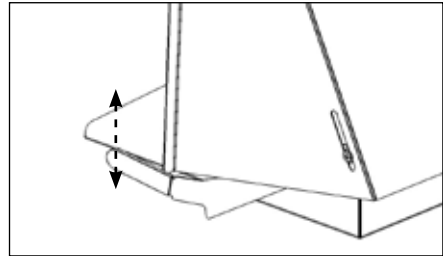
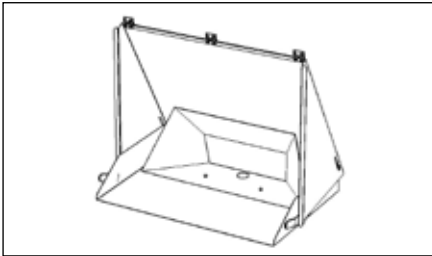

1. The adjustable back panel can be extended out from the CuttingStation to provide a deeper cutting space.

2. When the back panel is extended, the handles on either side drop down to lock it in position.

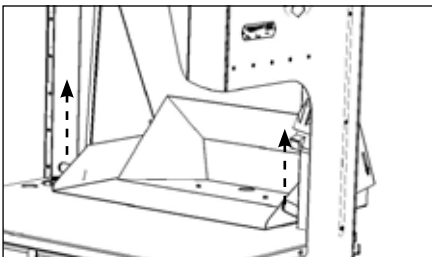

3. To extend or retract the panel, lift the handle on either side of the dust collector and push or pull in the direction required.

Take your CuttingStation™ to the next level with these optional extras

Contact the Armorgard team to find
out more about the optional extras
for your product.



Crane lifting eyes

For ease of
transportation



>>
Video: how to attach
the crane lifting eyes

Attaching the crane lifting eye kit (optional extra)

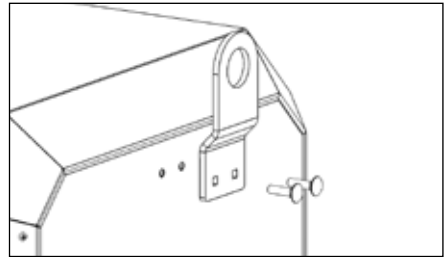
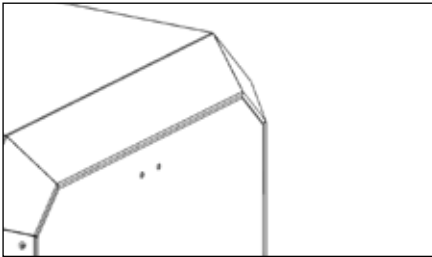

1. If adding crane lifting eyes to the CuttingStation, use a 13/32" metal drill bit to drill out the two pilot holes located on each side of your CuttingStation.

2. Thread the coach bolts through the lifting eyes.

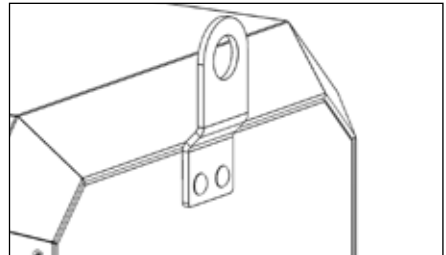
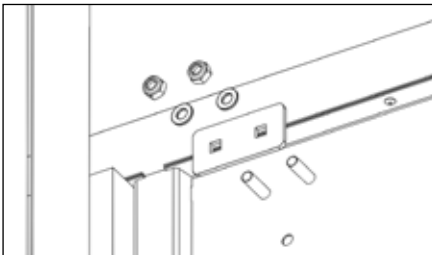

3. Inside the unit, add a backing plate, washers and nylocks to each bolt as shown.

4. Before lifting, a risk assessment must be performed by a qualified person to ensure the product is safe to lift.

Storing the unit

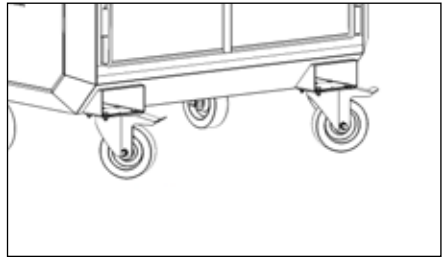

1. Ensure that all CuttingStation locks are secured after use, or when leaving the unit unattended. This is essential to maintain the security of the unit.

2. When the CuttingStation is in position, always ensure the caster brakes are used.

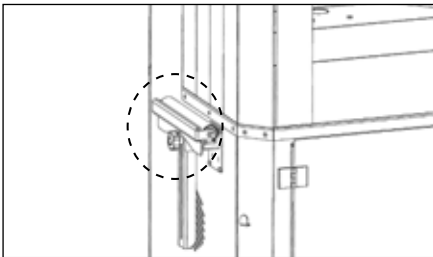

3. Ensure the star screws lock the arm in place, or store the arms inside the unit.

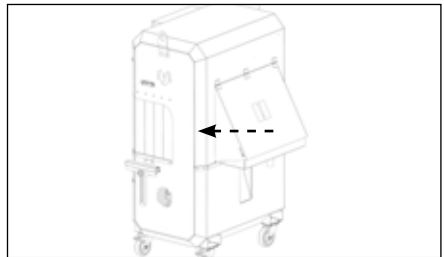

4. Ensure the back panel is pulled in.



Transporting the unit

The design of the CuttingStation makes transporting the product easy.

The unit comes as standard forklift pockets for transporting using a forklift. Please always take care when moving the CuttingStation. Use the heavy-duty casters for easy maneuvering even when fully loaded.

It is always advised only to lift the unit using the crane lifting eyes when the CuttingStation is empty of its contents.

All locks on the CuttingStation should be secured and keys removed and put in a safe place before moving the unit. To reduce damage, remove the support arms and place inside the unit. Ensure the back panel is pushed in.

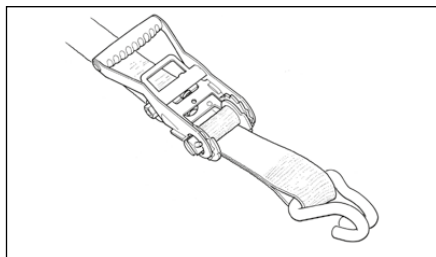

- 1.** Ensure that there are no trailing cables or protruding components.
- 2.** During transportation, ensure the CuttingStation is secured using straps or other measures.

Equipment care

The CuttingStation is weather resistant and finished with a durable powder coating, however it does not mean it is waterproof and we do not advise for the unit to be stored outdoors. It is always important to note that any electrical components or equipment susceptible to water damage should be sealed.

Always ensure that the product data plate remains visible and in good condition, especially the unique serial number.

Ongoing maintenance

It is important to check that the CuttingStation is not damaged before every use.

We recommend for you to check the hinges, locks, casters and crane lifting eyes every three months, to ensure that the CuttingStation can operate fully. If the CuttingStation will be under rigorous outdoor use, we recommend integrity checking regularly.

Always carry out integrity checks before lifting or transporting the unit.



Warranty

Armorgard products are built to last, and all have a manufacturer's warranty of seven years - please refer to the terms and conditions for what this covers.

Do not force entry into the product, as this could affect the warranty. Contact your padlock distributor if you require a replacement lock or key.

1 Limited Warranty

1.1 the Seller Warrants to Buyer That for a Period of Seven (7) Years From the Delivery of the Goods ("warranty Period"), Such Goods Will Materially Conform to the Seller's Published Specifications at the Time of Delivery and Will Be Free From Material Defects in Workmanship.

1.2 Except for the Limited Warranty Set Forth in Section 10.1, the Seller Makes No Warranty Whatsoever With Respect to the Goods, Including Any (a) Warranty of Merchantability; (B) Warranty of Fitness for a Particular Purpose; (C) Warranty of Title; or (D) Warranty Against Infringement of Intellectual Property Rights of a Third Party; Whether Express or Implied by Law, Course of Dealing, Course of Performance, Usage of Trade or Otherwise.

1.3 Products Manufactured by a Third Party ("third Party Product") May Constitute, Contain, Be Contained in, Incorporated Into, Attached to or Packaged Together With, the Goods. Third Party Products Are Not Covered by the Limited Warranty in Section 1.1. for the Avoidance of Doubt, the Seller Makes No Representations or Warranties With Respect to Any Third Party Product, Including Any (a) Warranty of Merchantability; (B) Warranty of Fitness for a Particular Purpose; (C) Warranty of Title; or (D) Warranty Against Infringement of Intellectual Property Rights of a Third Party; Whether Express or Implied by Law, Course of Dealing, Course of Performance, Usage of Trade or Otherwise.

1.4 the Seller Shall Not Be Liable for a Breach of the Limited Warranty in Section 10.1 if the:

1.4.1 Defect Arises Because the Buyer Failed to Follow the Seller's Oral or Written Instructions as to the Storage, Installation, Commissioning, Use or Maintenance of the Goods or (if There Are None) Good Trade Practice;

1.4.2 the Buyer Alters or Repairs the Goods Without the Written Consent of the Seller;

1.4.3 Defect Arises From Fair Wear and Tear (as Determined by the Seller in Its Sole and Absolute Discretion), Cosmetic Rust, Scratches, Dents, or Willful Damage, Negligence, Abnormal Working Conditions or Misuse, Environmental or Other External Factors;

1.4.4 the Buyer Makes Any Further Use of the Goods After Giving Notice of a Defect in Writing to the Buyer;

1.4.5 Defect Arises as a Result of the Seller Following Any Drawing, Design or Specification Supplied by the Buyer;

1.4.6 the Defect or Imperfection is of a Minor or Insignificant Nature in Respect of the Goods; or

1.4.7 the Goods Differ From Their Description or Specification as a Result of Changes Made to Ensure They Comply With Applicable Statutory or Regulatory Requirements.

1.5 Subject to Section 1.3 and 1.4 and the Seller's Right to Examine Such Goods, if Any of the Goods Do Not Comply With the Warranty in Section 1.1, the Seller's Liability Shall Be Limited (at the Seller's Option) to the Repair or Replacement of Such Goods (or the Defective Part(S) in Question) or the Refund of the Price (or a Proportionate Part of the Price), and the Seller Shall Have No Further Liability to the Buyer.

1.6 if the Seller So Requests, the Buyer Shall, at the Seller's Expense, Return the Goods or the Defective Part(S) in Question to the Seller. Any Goods Replaced Will Belong to the Seller and Any Repaired or Replacement Goods Will Be Guaranteed on These Terms.

1.7 the Remedies Set Forth in This Section 1 Shall Be the Buyer's Sole and Exclusive Remedy and the Seller's Entire Liability for Any Breach of the Limited Warranty Set Forth in Section 1.1.



Spare parts



Replacement
casters



Replacement
rubber mat



Replacement
light



Replacement
power strip

Other spare parts available. Please get in touch for more information.

Notes



Find us on social media:



UK Head Office

Unit 14-16, Standard Way, Fareham Industrial Park, Fareham, Hampshire, PO16 8XB
+44 (0) 23 9238 0280 | sales@armorgard.co.uk | www.armorgard.co.uk

France Office

+ 33 (0) 4 81 16 06 69
commercial@armorgard.fr
www.armorgard.fr

Australia Office

+61 (0) 1300 131 751
sales@armorgard.com.au
www.armorgard.com.au

New Zealand Office

0800 826 828
sales@armorgard.co.nz
www.armorgard.co.nz

North America Office

1-877-794-2848
info@armorgardusa.com
www.armorgardusa.com