

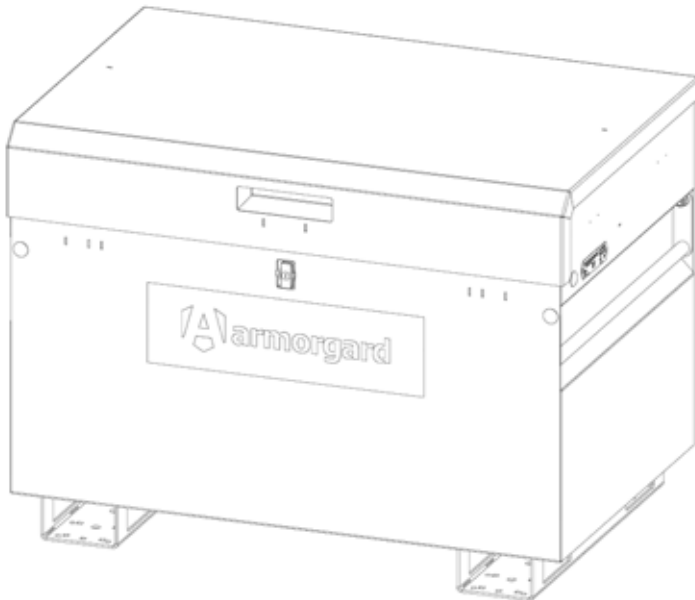

siteboss chestTM

Operational and maintenance manual

Suitable for: SB16, SB24



1-877-794-2848 >> info@armorgardusa.com



Welcome

Welcome to your Armorgard SiteBoss Chest. The perfect combination of security and safety, whether you're on the jobsite or in your truck. Please consult this manual for instructions on how to get the most from the unit.

Please read this operational and maintenance manual carefully prior to setting up the SiteBoss Chest. Always keep this manual with the product and read prior to use.

Contents

Safety information.....	4
Product specification.....	5
What's included.....	6
Tools you'll need.....	7
Getting to know your SiteBoss Chest.....	8
Padlock housing dimensions.....	9
How to use.....	10
Installing the padlock.....	11
Installing the rubber grommet.....	12
Electrical safety information.....	13
How to use the lock.....	14
Optional extras.....	15
Installing the casters.....	16
Attaching the crane lifting eye kit.....	17
Storing the unit.....	18
Transporting the unit.....	19
Equipment care & ongoing maintenance.....	20
Warranty.....	21
Spare parts.....	23



Safety information

- » Before using a SiteBoss Chest, ensure any relevant risk assessments are carried out. Armorgard cannot be responsible for accidents that occur due to negligence.
- » Ensure that the SiteBoss Chest is not damaged before using it.
- » Always lock the box and the casters (if applicable) when not in use or out of sight. Do NOT leave keys inside the unit while locking.
- » Only position the SiteBoss on stable and even ground to prevent it rolling over and causing injury or personal harm.
- » Always fully open the lid so the SlamStop engages on the gas strut. To close the lid, lift the SlamStop with one hand and begin shutting the lid with the other. Once the gas strut has cleared the SlamStop, ensure all limbs are fully outside of the chest before closing the lid completely. Always check that the area is clear before closing and guide the lid closed carefully.
- » Improper dangerous activities performed using the SiteBoss Chest increases the risk of personal injury, please follow the stated instructions to prevent incidents.
- » If casters are being installed, these must be installed according to our specification and should be checked regularly to ensure they are still fit for purpose.
- » This product should not be used for transporting or storing explosives, hazardous wastes, flammables or hazardous materials such as gas tanks, containers of solvents, dynamite, gunpowder, etc.
- » Any alteration to or unintended use of this product could create a danger of an explosion or other hazardous conditions that can result in serious personal injury, property damage or even death.
- » Only use UL or CSA listed electrical devices that meet the requirements of the local jurisdiction.
- » Always wear the appropriate PPE for the task you are performing, as outlined in your risk assessment or safe work practices.
- » The unit has an overall WLL of 2200 lbs.

While every effort has been made to ensure this operational and maintenance manual covers every aspect needed to operate your product safely, please take care when using the product and always operate with caution. Always liaise with management personnel on site for any additional operational restrictions that you need to be aware of.

Do	Don't
✓ Lock the box when leaving it unattended	✗ Leave keys inside unit when locking
✓ Lift SlamStop lid stay when closing lid	✗ Leave lid unlocked when unattended
✓ Integrity check the box before lifting	✗ Use box to store hazardous substances
✓ Fully unload before lifting	✗ Leave casters unlocked when in position

Product specification

Product code	Description	Weight (lbs)	External Dimensions W x D x H (inches)	Internal Dimensions W x D x H (inches)
SB16	Site Chest 4'x2'x2'	185	45.9 x 24.2 x 28.3	45.1 x 23.2 x 24.4
SB24	Site Chest 4'x2.5'x3'	240	45.9 x 29.9 x 33.5	45.1 x 28.9 x 29.5

SiteBoss™ Patent 2211899.6



What's included...



1x SiteBoss Chest



1x rubber grommet

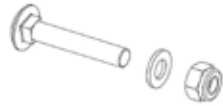

1x UltraLock fixing kit
(padlock not included)

Tools you'll need...



Adjustable wrench or ratchet and socket (11/16" socket for installing padlock and 1/2" socket for casters)



Rubber mallet or hammer (for adding rubber grommet)



Multiple people may be required to assist with lifting



Getting to know your SiteBoss Chest™

The perfect combination of security and safety, whether you're on the jobsite or in your truck

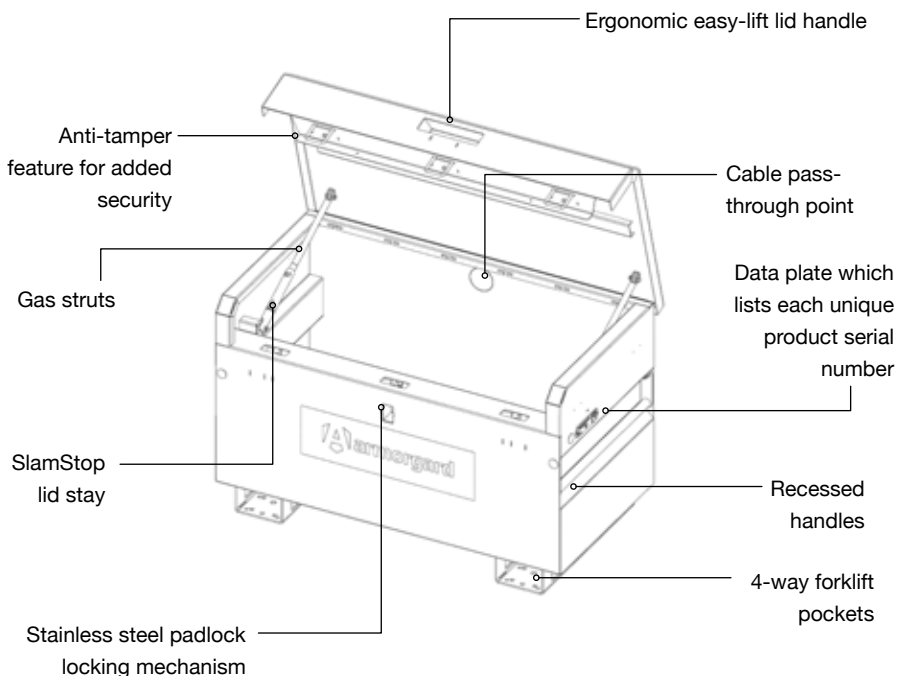

UltraLock



Forklift pockets



Gas struts
(300N)



SlamStop lid
stay



Cable pass
through point

Padlock housing dimensions

This lock system is designed to be used with a Master Lock No. 1, Master Lock No. 5, ABUS 41/50 or American Lock No. 50, or an equivalent sized lock. If you are using a padlock not listed above, it is your responsibility to make sure the lock mechanism is working correctly. Padlocks must meet ALL requirements listed in diagram.

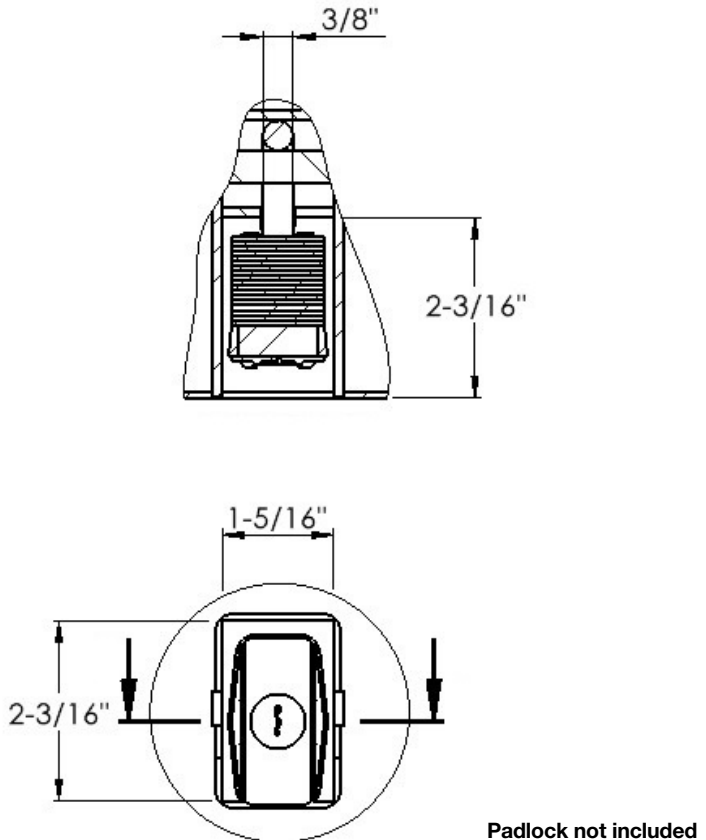



How to use

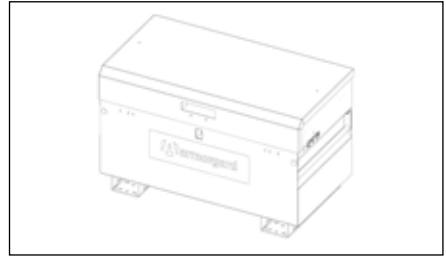
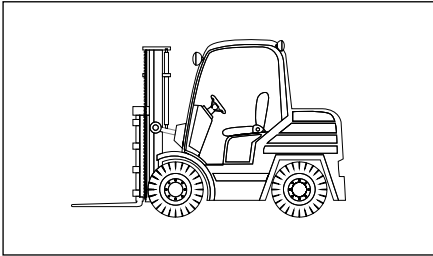

- 1.** You may require a forklift or pallet truck when unloading your SiteBoss Chest. Two or more people may be required to assist with lifting.

- 2.** The SiteBoss Chest arrives fully assembled.



- 3.** It is important to check that the product is not damaged upon arrival and all parts are intact.



>>
Video: how to install
the padlock

Installing the padlock

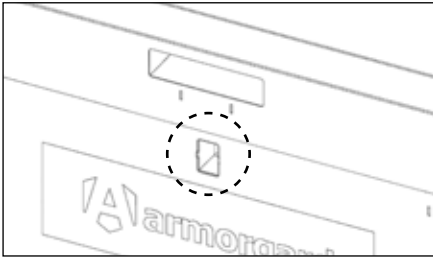

- 1.** To fit the padlock, locate the cavity where it will be installed.

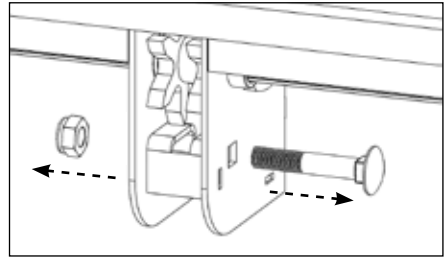

- 2.** Inside the product, on the back of the cavity, there will be a bolt with a nut. Remove this nut and the bolt to allow access for the padlock.

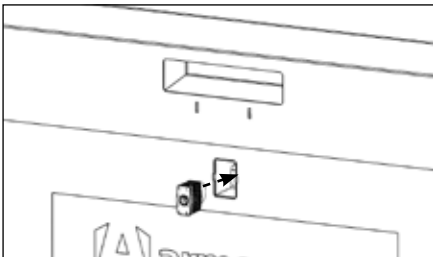

- 3.** Insert the shackle of the padlock inside the cavity. The keyhole should remain accessible from the front face. Make a note of your padlock's serial number.

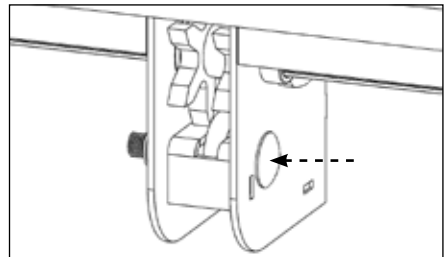

- 4.** Once the padlock is positioned, insert the bolt into place and use the nut to secure it together. Always check that the lock is in correct working order after installing, before the lid is closed.



>>
Video: how to install
the rubber grommet

Installing the rubber grommet

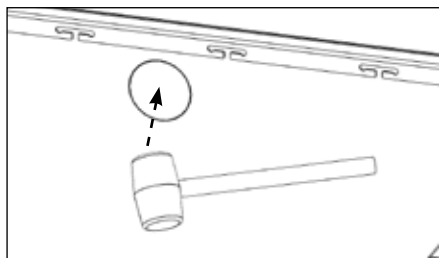

- 1.** Locate the cut-out plate in the body of the unit. With the help of a rubber mallet, carefully knock the cut-out plate from the inside.

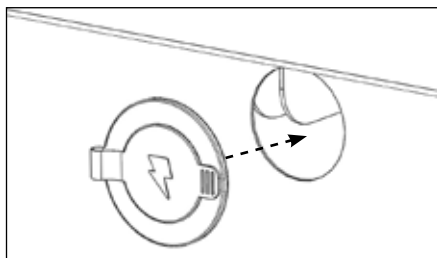

- 2.** Next, take the rubber grommet and place it from the outside to fit the cut-out. Ensure it is properly installed and no sharp edges are exposed.

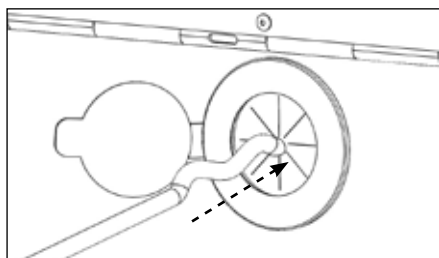

- 3.** When passing cords through the grommet, insert them from the outside.

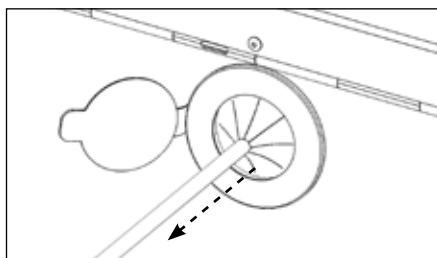

- 4.** After inserting, pull 2-3" of the cord back to make sure rubber fins are pointing out the box.

Electrical safety information

All electrical work MUST be performed properly with safety precautions. To prevent injury or damage to property, please ensure the below information is read carefully. Only use UL or CSA listed electrical devices that meet the requirements of the local jurisdiction.

Extension cords

- » Ensure that manufacturer's instructions and safety information are always followed.
- » Never use a damaged cord. Always check before using.
- » Always insert cords after the rubber grommet is safely in place.
- » You must not overload the extension cord.
- » You must only use cords that are designed for outdoor use.
- » When transporting the unit, ensure that all cords have been removed from the grommet.
- » Extension cords must not be connected to outlet that also supplies critical safety equipment.

Cordless battery chargers

- » Ensure that manufacturer's instructions and safety information are always followed. Chargers and batteries must be cared for properly following manufacturer's guidelines.
- » Place electrical components on shelf (if applicable).
- » If electrical components become wet or exposed to hazardous and flammable substances, switch off and discontinue use immediately.
- » Always check chargers and batteries will operate properly and are not damaged.
- » Do NOT come into contact with metal prongs when plugging in electrical components.
- » Electrical components must be kept away from flammable and hazardous substances.
- » Only place suitable jobsite equipment in the unit.



How to use the lock

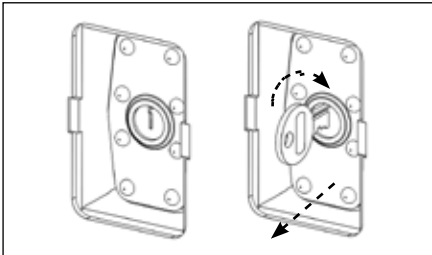

- 1.** Once the padlock is installed, to unlock the box, you will need to insert the key into the padlock. Twist it as normal, and this will release the lid.

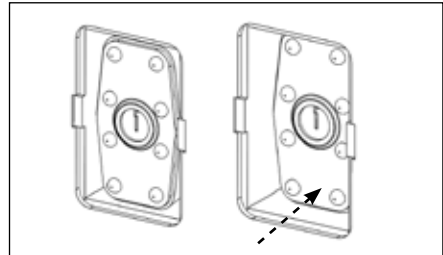

- 2.** To lock your product, you must close the lid and simply push the padlock in. Always double check that the locks are properly secured before leaving unattended.

Take your SiteBoss Chest™ to the next level with these optional extras

Contact the Armorgard team to find out more about the optional extras for your product.



Casters

To make your SiteBoss Chest mobile



Crane lifting eyes

To transport by crane



>> Video: how to attach the casters

Attaching the casters (optional extra)

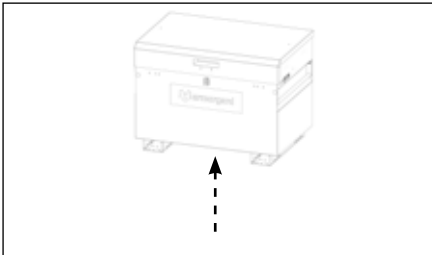

- 1.** For the SiteBoss Chests that can be installed with casters, lift the box on to a stable platform to ensure it does not roll and cause injury. The box **MUST** be empty when installing casters.

- 2.** Armorgard casters kits come with two swivel and two swivel-braked casters. We recommend attaching the braked casters on opposite corners.

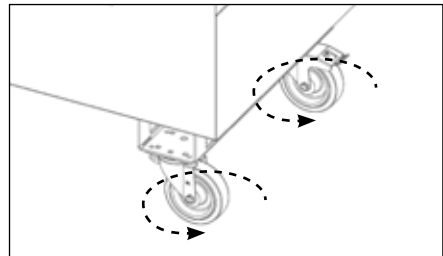
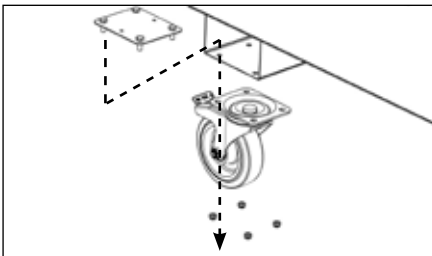

- 3.** Insert the caster plate and tighten the nuts from the bottom using the adjustable wrench. Repeat for all.

- 4.** Repeat step three for the other wheels. Once complete, check all nuts are tight, and then ensure the casters can swivel 360° before lowering the SiteBoss Chest.



>>
Video: how to attach
the crane lifting eyes

Attaching the crane lifting eye kit (optional extra)

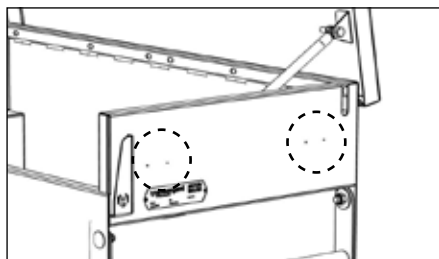

1. For the SiteBoss Chests that can be attached with crane lifting eyes, use a 13/32" metal drill bit to drill out the four pilot holes located on each side of your SiteBoss Chest.

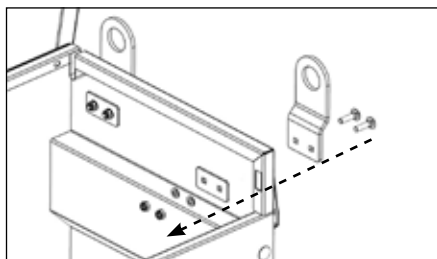

2. Thread the coach bolts through the lifting eyes, then back through the box. Inside the box, add a backing plate, washers and nylocks to each bolt as shown.

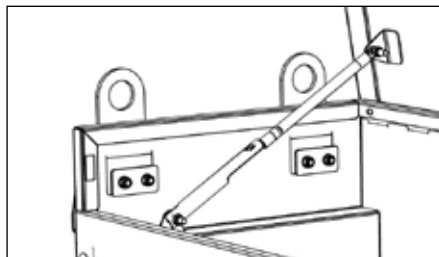

3. Always check the working load limit of the product before carrying out a lift.

Before lifting, a risk assessment must be performed by a qualified person to ensure the product is safe to lift.



Storing the unit

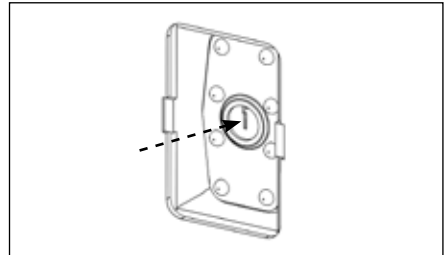
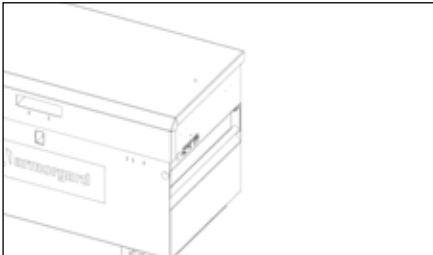

- 1.** The flat sides and recessed handles of the SiteBoss Chest can help save space when storing the unit.

- 2.** Ensure that the lock is secured when leaving the SiteBoss Chest unattended. This is essential to maintain the maximum security of the box. Test this by trying to pull the lid up and open.

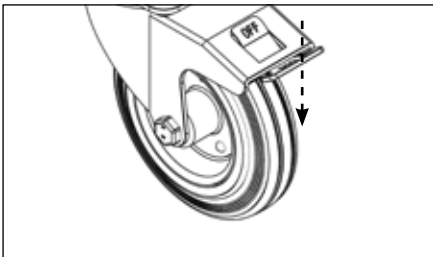

- 3.** When the SiteBoss Chest is in position, always ensure the caster brakes are used.

Transporting the unit

The design of the SiteBoss Chest makes transporting the product easy.

The units come with forklift pockets for transporting using a forklift or pallet truck. Optional casters can be installed to these boxes using the pre-drilled holes.

Please note that boxes may require more than one person to lift, and it is always advised to lift the boxes when they are empty of contents.

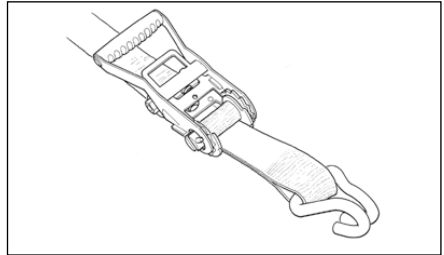
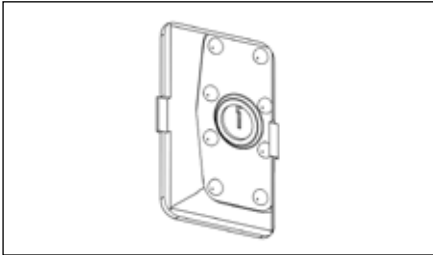

- 1.** Always secure the lock and remove key before lifting the unit, to ensure that the lid does not open unexpectedly. Do not leave the key inside the padlock.

- 2.** When transporting, ensure the box is secured using straps or other necessary measures.



Equipment care

The SiteBoss Chest is weather resistant and finished with a durable powder coating, so it is suitable for outdoor use, however, it does not mean it is waterproof. It is always important to note that any electrical components or equipment susceptible to water damage should be sealed, or removed in wet conditions.

Always ensure that the product data plate remains visible and in good condition, especially the unique serial number.

Ongoing maintenance

It is important to check that the SiteBoss Chest is not damaged before every use.

We recommend for you to check the gas struts, locks, SlamStop lid stay and hinges every three months, to ensure that the SiteBoss Chest can operate fully. If the SiteBoss Chest will be under rigorous use, we recommend integrity checking regularly.

Always carry out integrity checks before lifting the box.

Apply light oil to hinges for smoother operation.

Warranty

Armorgard products are built to last, and all have a manufacturer's warranty of seven years - please refer to the terms and conditions for what this covers.

Do not force entry into the product, as this could affect the warranty. Contact your padlock distributor if you require a replacement lock or key.

1 Limited Warranty

1.1 the Seller Warrants to Buyer That for a Period of Seven (7) Years From the Delivery of the Goods ("warranty Period"), Such Goods Will Materially Conform to the Seller's Published Specifications at the Time of Delivery and Will Be Free From Material Defects in Workmanship.

1.2 Except for the Limited Warranty Set Forth in Section 10.1, the Seller Makes No Warranty Whatsoever With Respect to the Goods, Including Any (a) Warranty of Merchantability; (B) Warranty of Fitness for a Particular Purpose; (C) Warranty of Title; or (D) Warranty Against Infringement of Intellectual Property Rights of a Third Party; Whether Express or Implied by Law, Course of Dealing, Course of Performance, Usage of Trade or Otherwise.

1.3 Products Manufactured by a Third Party ("third Party Product") May Constitute, Contain, Be Contained in, Incorporated Into, Attached to or Packaged Together With, the Goods. Third Party Products Are Not Covered by the Limited Warranty in Section 1.1. for the Avoidance of Doubt, the Seller Makes No Representations or Warranties With Respect to Any Third Party Product, Including Any (a) Warranty of Merchantability; (B) Warranty of Fitness for a Particular Purpose; (C) Warranty of Title; or (D) Warranty Against Infringement of Intellectual Property Rights of a Third Party; Whether Express or Implied by Law, Course of Dealing, Course of Performance, Usage of Trade or Otherwise.

1.4 the Seller Shall Not Be Liable for a Breach of the Limited Warranty in Section 10.1 if the:



1.4.1 Defect Arises Because the Buyer Failed to Follow the Seller's Oral or Written Instructions as to the Storage, Installation, Commissioning, Use or Maintenance of the Goods or (if There Are None) Good Trade Practice;

1.4.2 the Buyer Alters or Repairs the Goods Without the Written Consent of the Seller;

1.4.3 Defect Arises From Fair Wear and Tear (as Determined by the Seller in Its Sole and Absolute Discretion), Cosmetic Rust, Scratches, Dents, or Willful Damage, Negligence, Abnormal Working Conditions or Misuse, Environmental or Other External Factors;

1.4.4 the Buyer Makes Any Further Use of the Goods After Giving Notice of a Defect in Writing to the Buyer;

1.4.5 Defect Arises as a Result of the Seller Following Any Drawing, Design or Specification Supplied by the Buyer;

1.4.6 the Defect or Imperfection is of a Minor or Insignificant Nature in Respect of the Goods; or

1.4.7 the Goods Differ From Their Description or Specification as a Result of Changes Made to Ensure They Comply With Applicable Statutory or Regulatory Requirements.

1.5 Subject to Section 1.3 and 1.4 and the Seller's Right to Examine Such Goods, if Any of the Goods Do Not Comply With the Warranty in Section 1.1, the Seller's Liability Shall Be Limited (at the Seller's Option) to the Repair or Replacement of Such Goods (or the Defective Part(S) in Question) or the Refund of the Price (or a Proportionate Part of the Price), and the Seller Shall Have No Further Liability to the Buyer.

1.6 if the Seller So Requests, the Buyer Shall, at the Seller's Expense, Return the Goods or the Defective Part(S) in Question to the Seller. Any Goods Replaced Will Belong to the Seller and Any Repaired or Replacement Goods Will Be Guaranteed on These Terms.

1.7 the Remedies Set Forth in This Section 1 Shall Be the Buyer's Sole and Exclusive Remedy and the Seller's Entire Liability for Any Breach of the Limited Warranty Set Forth in Section 1.1.

Spare parts



Gas struts



SlamStop
safety stay

Other spare parts available. Please get in touch for more information.



Find us on social media:



UK Head Office

Unit 14-16, Standard Way, Fareham Industrial Park, Fareham, Hampshire, PO16 8XB
+44 (0) 23 9238 0280 | sales@armorgard.co.uk | www.armorgard.co.uk

France Office

+ 33 (0) 4 81 16 06 69
commercial@armorgard.fr
www.armorgard.fr

Australia Office

+61 (0) 1300 131 751
sales@armorgard.com.au
www.armorgard.com.au

New Zealand Office

0800 826 828
sales@armorgard.co.nz
www.armorgard.co.nz

North America Office

1-877-794-2848
info@armorgardusa.com
www.armorgardusa.com