



fittingstorTM

Operational and maintenance manual

Suitable for: FC4-T, FC6-T



Find us on social media:



UK Head Office

Unit 14-16, Standard Way, Fareham Industrial Park, Fareham, Hampshire, PO16 8XB
+44 (0) 23 9238 0280 | sales@armorgard.co.uk | www.armorgard.co.uk

France Office

+ 33 (0) 4 81 16 06 69
commercial@armorgard.fr
www.armorgard.fr

Australia Office

+61 (0) 1300 131 751
sales@armorgard.com.au
www.armorgard.com.au

New Zealand Office

0800 826 828
sales@armorgard.co.nz
www.armorgard.co.nz

North America Office

1-877-794-2848
info@armorgardusa.com
www.armorgardusa.com

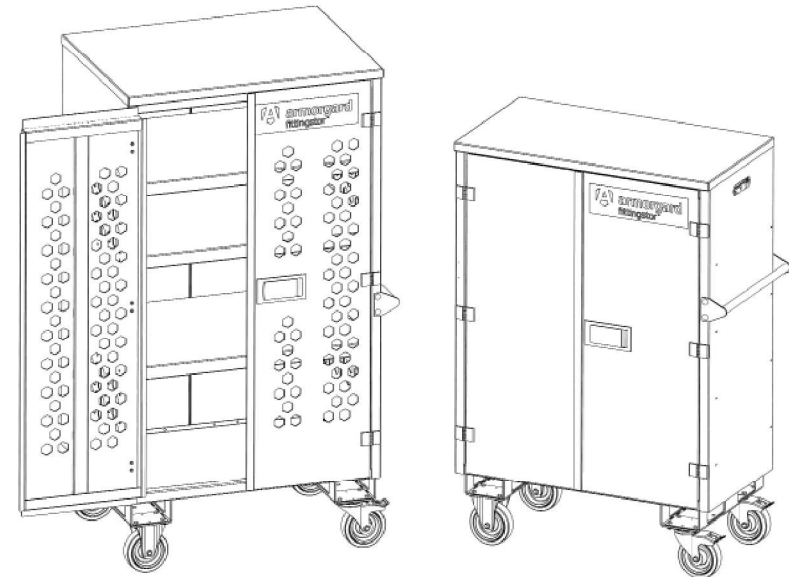

1-877-794-2848 >> info@armorgardusa.com



Welcome

Welcome to your Armorgard FittingStor. Tough, tidy, transportable - a design that brings security, organization and mobility together. Please consult this manual for instructions on how to get the most from your product.

Please read this operational and maintenance manual carefully prior to setting up the FittingStor. Always keep this manual with the product and read prior to use.

Notes



Spare parts



Replacement
lock system kit



Replacement
casters



Replacement
shelves (FC4-T)

Other spare parts available. Please get in touch for more information.

Contents

Safety information.....	4
Product specification.....	5
What's included.....	6
Tools you'll need.....	7
Getting to know your FittingStor.....	8
Padlock housing.....	10
How to assemble.....	11
Installing the casters.....	12
Attaching the handle.....	13
Fitting shelves on the FC4-T.....	14
How to use the lock.....	15
Storing the unit.....	17
Transporting the unit.....	18
Equipment care & ongoing maintenance.....	19
Warranty.....	20
Spare parts.....	22
Notes.....	23



Safety information

- » Before using a FittingStor, ensure any relevant risk assessments are carried out. Armorgard cannot be responsible for accidents that occur due to negligence.
- » Ensure that the FittingStor is not damaged before using it.
- » Care should be taken to ensure contents do not make the unit unstable. When loading, ensure weight is evenly distributed and that heavier items are ALWAYS loaded in the base.
- » Do not force casters over uneven ground at risk of the unit tipping over.
- » Only position the FittingStor on stable and even ground to prevent it rolling over and causing injury or personal harm.
- » Improper dangerous activities performed using the FittingStor increases the risk of personal injury, please follow the stated instructions to prevent incidents.
- » If casters are being installed, these must be installed according to our specification and should be checked regularly to ensure they are still fit for purpose.
- » You must close doors before putting the FittingStor in motion for stability and to prevent content and product damage.
- » Always lock the FittingStor when it's not in use or out of sight. Do NOT leave keys inside the unit while locking.
- » Do not put hands, arms or legs near the open edge while closing the doors.
- » Any alteration to or unintended use of this product could create a danger of an explosion or other hazardous conditions that can result in serious personal injury, property damage or even death.
- » Always wear the appropriate PPE for the task you are performing, as outlined in your risk assessment or safe work practices.
- » This product should not be used for transporting or storing explosives, hazardous wastes, flammables or hazardous materials such as gas tanks, containers of solvents, dynamite, gunpowder, etc.

1.4.1 Defect Arises Because the Buyer Failed to Follow the Seller's Oral or Written Instructions as to the Storage, Installation, Commissioning, Use or Maintenance of the Goods or (if There Are None) Good Trade Practice;

1.4.2 The Buyer Alters or Repairs the Goods Without the Written Consent of the Seller;

1.4.3 Defect Arises From Fair Wear and Tear (as Determined by the Seller in Its Sole and Absolute Discretion), Cosmetic Rust, Scratches, Dents, or Willful Damage, Negligence, Abnormal Working Conditions or Misuse, Environmental or Other External Factors;

1.4.4 The Buyer Makes Any Further Use of the Goods After Giving Notice of a Defect in Writing to the Buyer;

1.4.5 Defect Arises as a Result of the Seller Following Any Drawing, Design or Specification Supplied by the Buyer;

1.4.6 The Defect or Imperfection is of a Minor or Insignificant Nature in Respect of the Goods; or

1.4.7 The Goods Differ From Their Description or Specification as a Result of Changes Made to Ensure They Comply With Applicable Statutory or Regulatory Requirements.

1.5 Subject to Section 1.3 and 1.4 and the Seller's Right to Examine Such Goods, if Any of the Goods Do Not Comply With the Warranty in Section 1.1, the Seller's Liability Shall Be Limited (at the Seller's Option) to the Repair or Replacement of Such Goods (or the Defective Part(S) in Question) or the Refund of the Price (or a Proportionate Part of the Price), and the Seller Shall Have No Further Liability to the Buyer.

1.6 If the Seller So Requests, the Buyer Shall, at the Seller's Expense, Return the Goods or the Defective Part(S) in Question to the Seller. Any Goods Replaced Will Belong to the Seller and Any Repaired or Replacement Goods Will Be Guaranteed on These Terms.

1.7 The Remedies Set Forth in This Section 1 Shall Be the Buyer's Sole and Exclusive Remedy and the Seller's Entire Liability for Any Breach of the Limited Warranty Set Forth in Section 1.1.



Warranty

Armorgard products are built to last, and all have a manufacturer’s warranty of seven years - please refer to the terms and conditions for what this covers.

Do not force entry into the product, as this could affect the warranty. Contact your padlock distributor if you require a replacement lock or key.

1 Limited Warranty

1.1 The Seller Warrants to Buyer That for a Period of Seven (7) Years From the Delivery of the Goods (“warranty Period”), Such Goods Will Materially Conform to the Seller’s Published Specifications at the Time of Delivery and Will Be Free From Material Defects in Workmanship.

1.2 Except for the Limited Warranty Set Forth in Section 10.1, the Seller Makes No Warranty Whatsoever With Respect to the Goods, Including Any (a) Warranty of Merchantability; (B) Warranty of Fitness for a Particular Purpose; (C) Warranty of Title; or (D) Warranty Against Infringement of Intellectual Property Rights of a Third Party; Whether Express or Implied by Law, Course of Dealing, Course of Performance, Usage of Trade or Otherwise.

1.3 Products Manufactured by a Third Party (“third Party Product”) May Constitute, Contain, Be Contained in, Incorporated Into, Attached to or Packaged Together With, the Goods. Third Party Products Are Not Covered by the Limited Warranty in Section 1.1. for the Avoidance of Doubt, the Seller Makes No Representations or Warranties With Respect to Any Third Party Product, Including Any (a) Warranty of Merchantability; (B) Warranty of Fitness for a Particular Purpose; (C) Warranty of Title; or (D) Warranty Against Infringement of Intellectual Property Rights of a Third Party; Whether Express or Implied by Law, Course of Dealing, Course of Performance, Usage of Trade or Otherwise.

1.4 The Seller Shall Not Be Liable for a Breach of the Limited Warranty in Section 10.1 if the:

- » Do not exceed shelf capacity of 330 lbs.
- » The unit has an overall WLL of 1400 lbs.
- » When transporting, the doors must be locked shut and the product securely fastened to the vehicle.
- » Only use UL or CSA listed electrical devices that meet the requirements of the local jurisdiction.

Whilst every effort has been made to ensure this operational and maintenance manual covers every aspect needed to operate your product safely, please take care when using the product and always operate with caution. Always liaise with management personnel on site for any additional operational restrictions that you need to be aware of.

Do	Don't
✓ Lock the unit when leaving it unattended	✗ Attempt to move over uneven/rough terrain
✓ Use the brakes when unit is stationary	✗ Leave doors open when unattended
✓ Integrity check the box before moving	✗ Use to store hazardous substances
✓ Use the base for storing heavier items	✗ Leave keys inside unit when locking

Product specification

Product code	Description	Weight (lbs)	External dimensions W x D x H (inches)	Internal dimensions W x D x H (inches)
FC4-T	FittingStor	306	43.7 x 22.4 x 62	40.6 x 20.1 x 50.8
FC6-T	FittingStor	339	42.1 x 29.8 x 74.2	39 x 27.6 x 62.8



What's included...



1x FittingStor unit
(FC4-T/FC6-T)

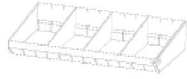

3x shelves
(FC4-T)



1x caster kit



1x handle kit

Equipment care

The FittingStor is weather resistant and finished with a durable powder coating, so it is suitable for outdoor use, however, the unit should not be kept outside in wet conditions. It is always important to note that any electrical components or equipment susceptible to water damage should be sealed.

Always ensure that the product data plate remains visible and in good condition, especially the unique serial number.

Ongoing maintenance

It is important to check that the FittingStor is not damaged before every use.

We recommend for you to check the hinges, locks, shelves and latches every three months, to ensure that the FittingStor can operate fully. If the FittingStor will be under rigorous use, we recommend integrity checking regularly.

Always carry out integrity checks before lifting the box.

Apply light oil to hinges for smoother operation.



Transporting the unit

The design of the FittingStor makes transporting the product easy.

The FittingStors come with forklift pockets for transporting using a forklift or pallet truck. Casters for mobility must be fitted following the guidelines in this manual.

Please note that the product requires more than one person to lift, and it is always advised to lift the boxes when they are empty of contents.

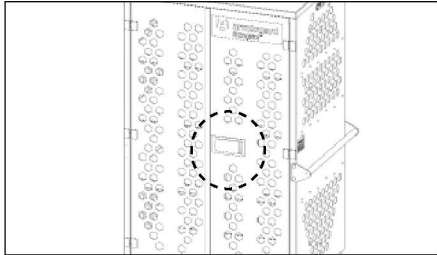

1. Always secure the padlock before lifting the unit, to ensure that the unit does not open unexpectedly.

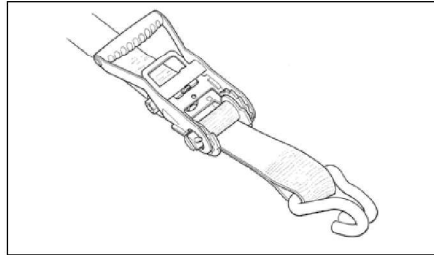

2. When transporting, ensure the product is secured using straps or other necessary measures.

Tools you'll need...



33/64" wrench
or adjustable
wrench
(to add casters
and handle)



Getting to know your FittingStor™

Tough, tidy, transportable - a design that brings security, organization and mobility together.

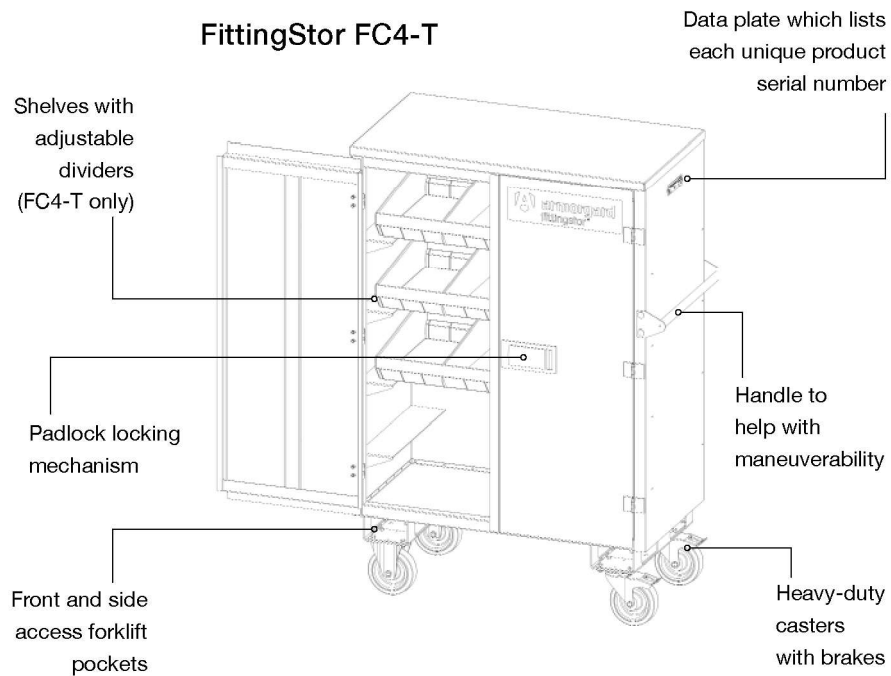

T-Latch Lock



Forklift pockets



Heavy-duty casters



Suitable for use on-site



Product with handles

Storing the unit

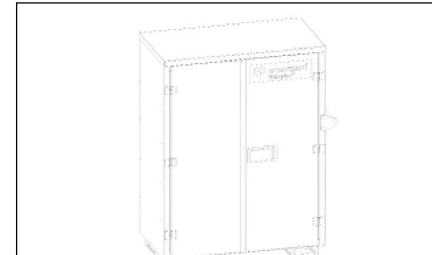

1. The design of the FittingStor can help save space when storing the unit.

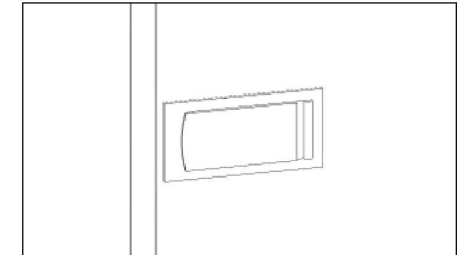

2. Ensure that all locks are secured when leaving the FittingStor unattended. This is essential to maintain the maximum security of the box.

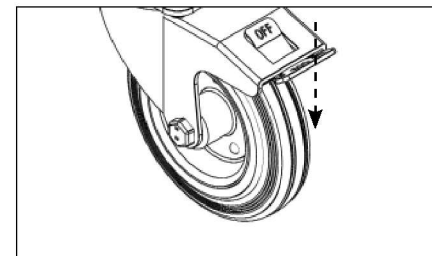

3. When the FittingStor is in position, always ensure the caster brakes are used.

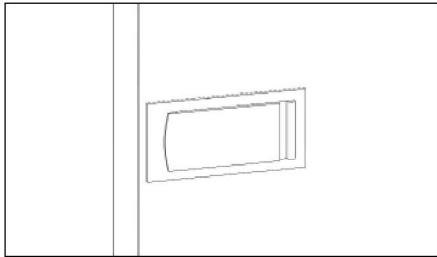

5. To lock the unit, shut the door, then open the cover plate to expose the locking mechanism.

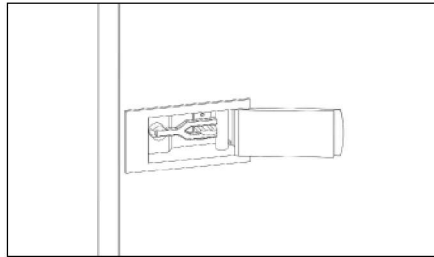

6. Ensure the T Handle is parallel to the front face of the door.

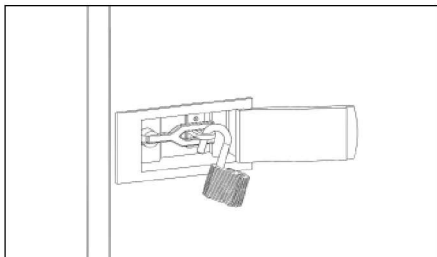

7. Slide an unlocked padlock into the inner shackle of the pocket to prevent the movement of the T Handle.

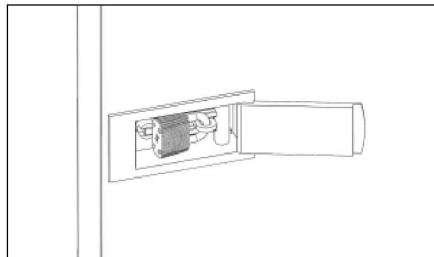

8. Lock the padlock, and fit it into the lock housing. After removing the key, the cover plate should be able to close easily.

FittingStor FC6-T

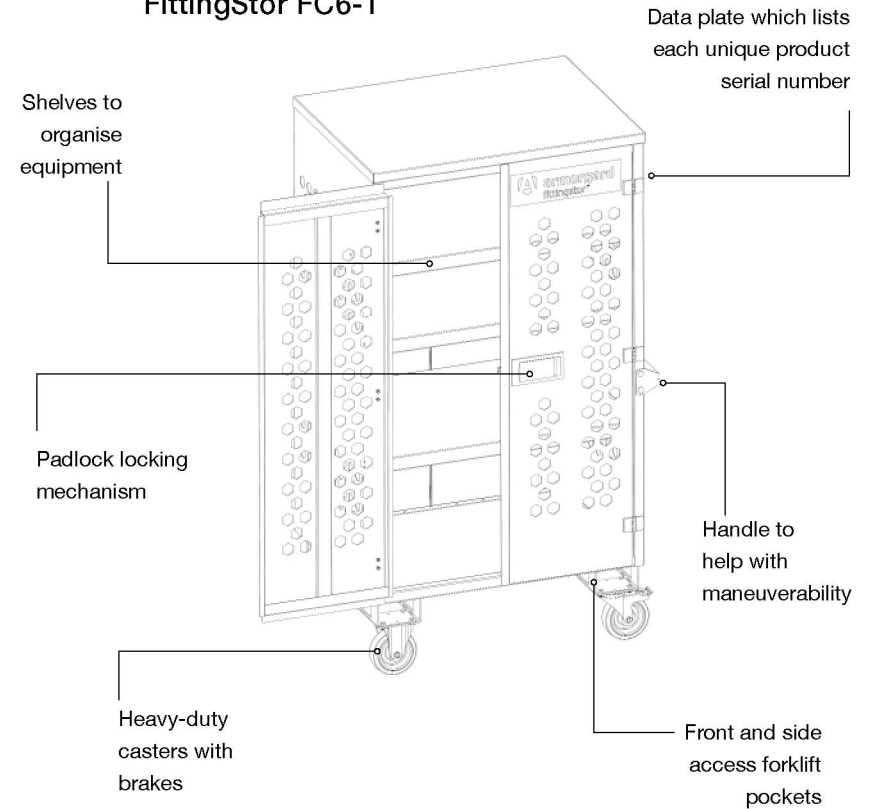

Shelves



Padlock housing dimensions

This lock system is designed to be used with a Master Lock No. 1, Master Lock No. 5, ABUS 41/50 or American Lock No. 50, or an equivalent sized lock. If you are using a padlock not listed above, it is your responsibility to make sure the lock mechanism is working correctly. Padlocks must meet ALL requirements listed in diagram.

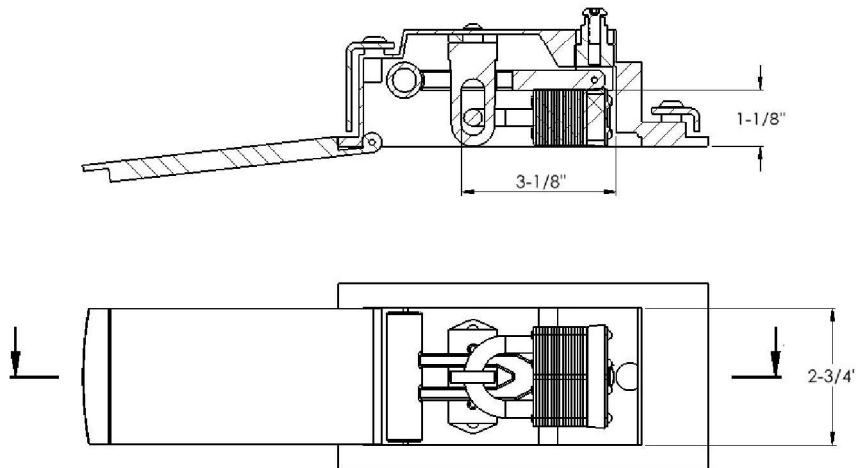

Padlock not included



»
Video: how to use
T-Latch Lock

How to use the lock

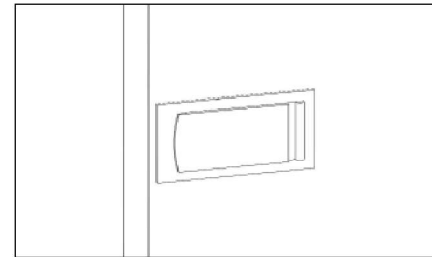

- 1.** To open the unit, locate the lock housing at the center of the door. Open the cover plate to expose the locking mechanism.

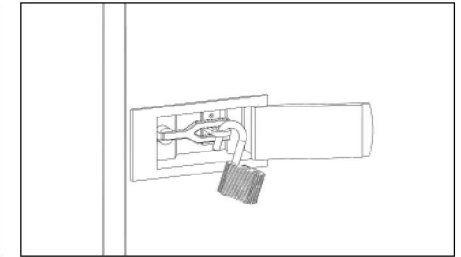

- 2.** Unlock the padlock and remove it.

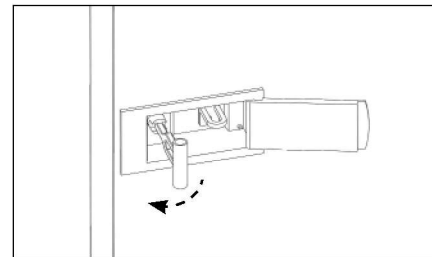

- 3.** Grab the T Handle and swing it to the left until it's perpendicular to the front face of the door.

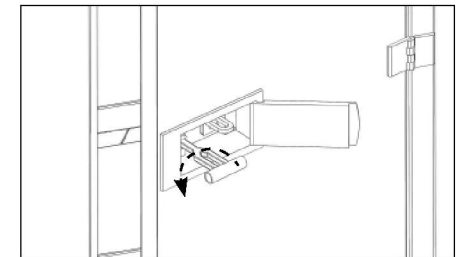

- 4.** Twist the handle 90° to release the door and pull to open it.



Fitting shelves on the FC4-T

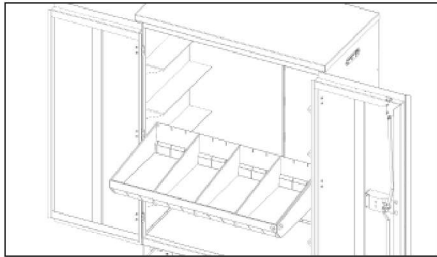

- 1.** Locate the shelf brackets in each side of the cabinet body of the FC4-T.

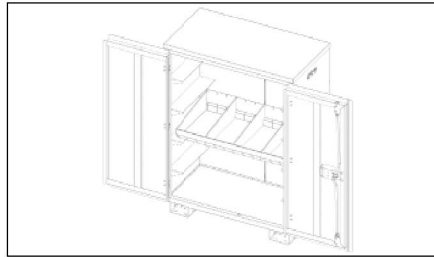

- 2.** Slide the shelf into the interior of the FittingStor and let it rest on the top surface of the brackets, until it touches the rear of the cabinet.

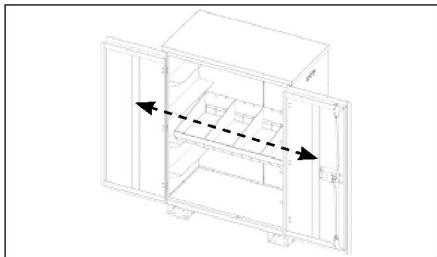

- 3.** Please note that the adjustable shelf will ONLY come out if the doors are both fully open 180 degrees.

How to assemble

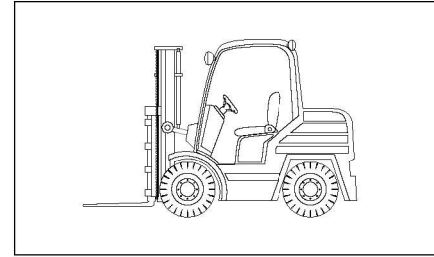

- 1.** You may require a forklift or pallet truck when unloading your FittingStor.

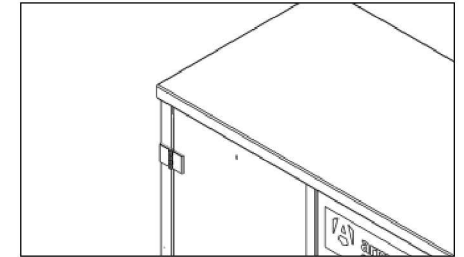

- 2.** It is important to check that the product is not damaged upon arrival and all parts are intact.



»
Video: how to attach
the casters

Installing the casters

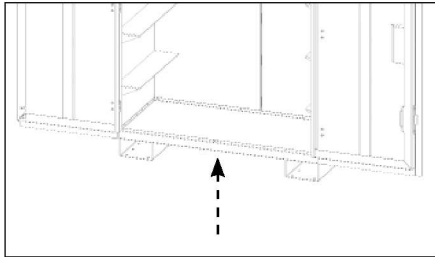

- 1.** Lift the FittingStor onto a stable platform to ensure it does not roll and cause injury. The unit **MUST** be empty when installing casters. Two or more people may be required to assist with lifting.

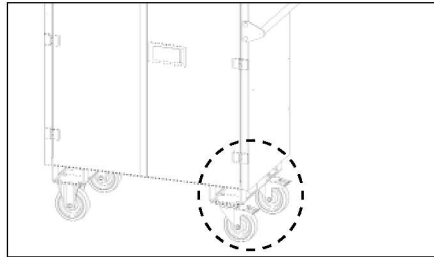

- 2.** Two of the casters are swivel-braked. We recommend installing the 2x braked casters on same side, and if applicable, where the side handle is located.

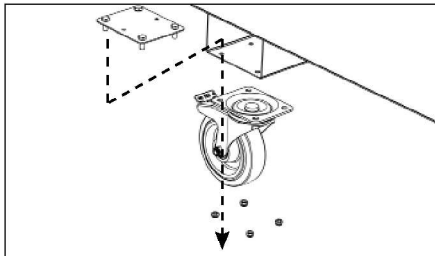

- 3.** Insert the caster plate and tighten the nuts from the bottom using the adjustable wrench.

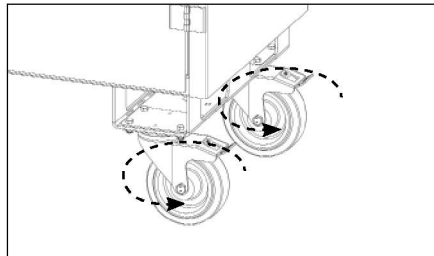

- 4.** Repeat step three for the other wheels. Once complete, check all nuts are tight, and then ensure the two swivel casters can swivel 360° before lowering the FittingStor.



»
Video: how to attach
the handle

Attaching the handle

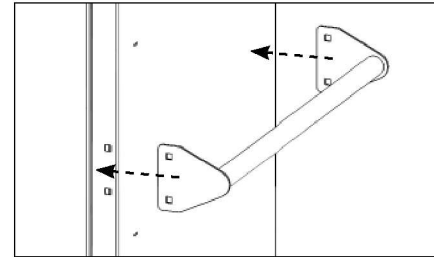

- 1.** Locate the outer pre-drilled holes near the corner of the cabinets. Take the handle and align the unit holes with the ones in the plate.

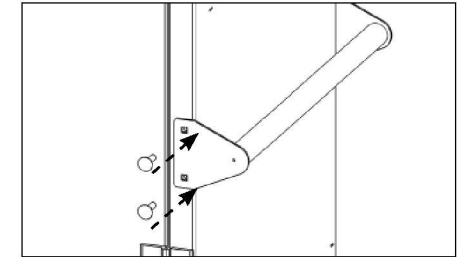

- 2.** Feed the bolts through the handle into the cabinet.

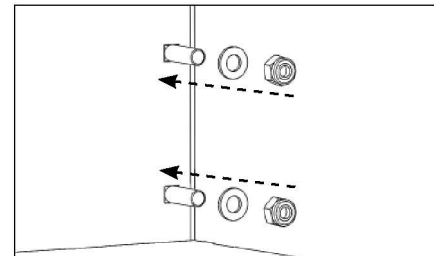

- 3.** With the doors open, fix the washer and nut onto the fed-through bolts starting at the front of the cabinet. Please note that multiple people may be needed to attach the handle for the FC4.