

INSTRUCTIONS FOR MODELS

SA-1409-24
SA-1409-36
SA-1409-48

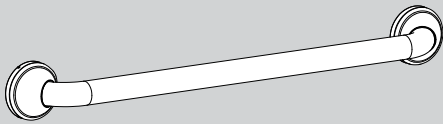

NEED HELP?

For additional assistance or service please contact:

SPEAKMAN®

 800-537-2107

 customerservice@speakman.com

 www.speakman.com

92-SA-1409-02

TOOLS AND SUPPLIES

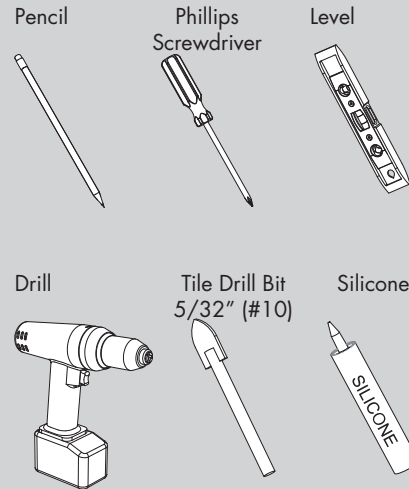



HELPFUL TOOLS & SUPPLIES:



IMPORTANT

 **WARNING:** Risk of personal injury. The wall plates on the grab bar must be mounted to the brace between the wall studs. Doing so will ensure that the weight of the user is adequately supported.

 **CAUTION:** Risk of property damage. For installation to ceramic tile: Apply light, even pressure to avoid cracking the tile. Use a 5/32" or #10 drill bit to drill through the tile. *Do not drill into the bracing.*

 **WARNING:** Risk of property damage. For installation to ceramic tile: Apply silicone sealant into the drilled holes before securing the wall plates to the finished surface. This will reduce the risk of water damage behind the finished surface.

- Be sure to read instructions thoroughly before beginning installation. Do not overtighten any connections or damage may occur. This Grab Bar meets ADA requirements when installed properly.
- This product is considered ADA compliant when located and mounted into a structural support per ADA guidelines. Refer to ADA guidelines before installing this product.
- Before installing finished wall material, install bracing between the wall studs where the wall plates will be mounted.
- The appearance of your product may differ from the illustration. The installation instructions still apply.
- Observe all local plumbing codes and building codes.

SAFETY TIPS

Cover your drain to prevent loss of parts. Be sure to wear eye protection while cutting pipe.

MAINTENANCE

Your new Speakman Product is designed for years of trouble-free performance. Keep it looking new by cleaning it periodically with a soft cloth. The use of harsh chemicals and abrasives on any of the Speakman custom finish products may damage the finish and void the product warranty. Please be sure to only use approved cleaners. Please contact Speakman for any clarification of acceptable cleaners.

WARRANTY

Warranty information can be found at:
www.speakman.com

1 Place Grab Bar in desired position on wall, being sure that there is sufficient blocking within the wall. Level if desired. Mark three (3) holes from each Wall Plate onto wall with pencil. **NOTE:** If installing thru drywall, proceed to **Step 4.**

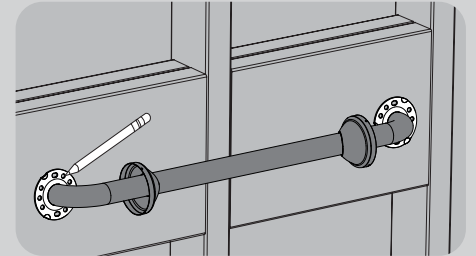

2 IF MOUNTING THRU TILE WALL: Drill thru tile only using a 5/32" (#10) drill bit that is designed for tile.

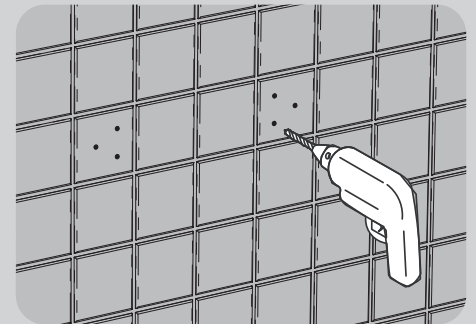

3 IF MOUNTING THRU TILE WALL: Apply Silicone Sealant into the six (6) drilled holes.

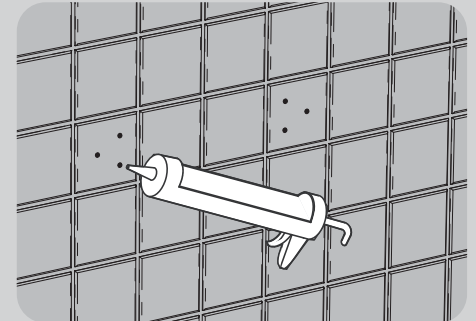

4

Secure each wall plate to wall using three (3) of the screws provided.

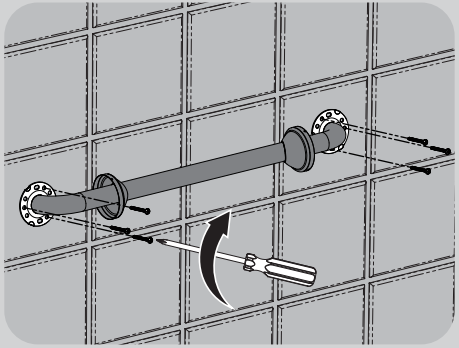

5

Slide Escutcheons over Wall plates and snap in place. Ensure the Escutcheons are kept into position.

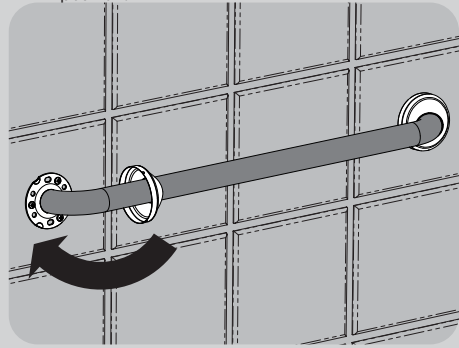

SA-1409 ROUGH-IN DIAGRAM

SPEAKMAN®

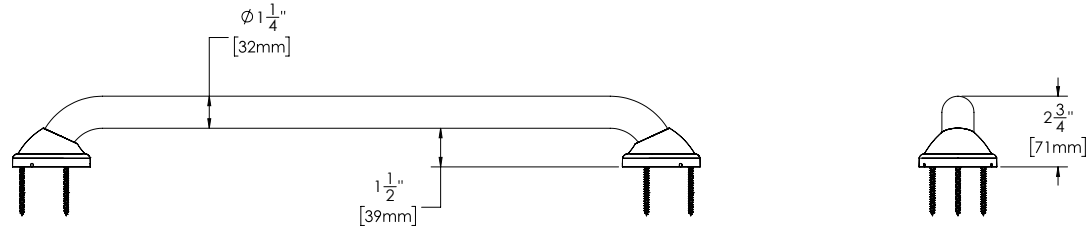

SA-1409-24

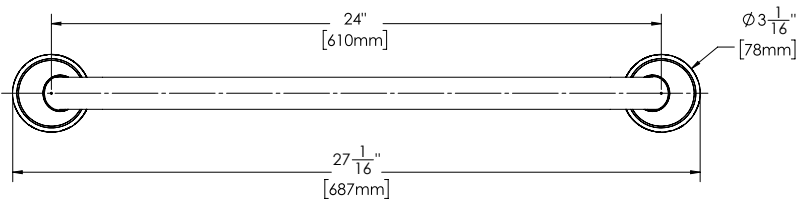

SA-1409-36

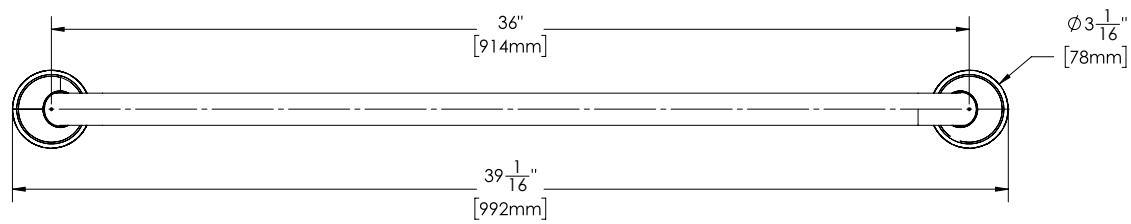

SA-1409-48

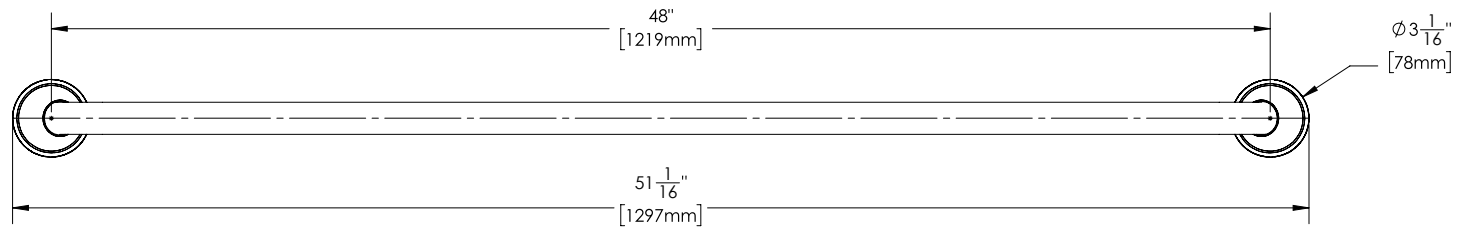

DIMENSIONS SUBJECT TO CHANGE WITHOUT NOTICE.