

SPECIFICATION:

JOSAM SERIES 45830 FABRICATED STAINLESS STEEL (TYPE 304) LINER TO FIT DRAINS OR SINKS WITH 16" TOPS AND 6" SUMP DEPTHS, WITH CLOSE-FIT BOTTOM OUTLET AND PERFORATED SS GRATE.

**SS DRAIN/SINK
LINER FOR 16" TOP x
6" DEEP SIZES**

SERIES **45830**

SEE 41600 TOPS DWG. FOR GRATE OPTION DETAILS

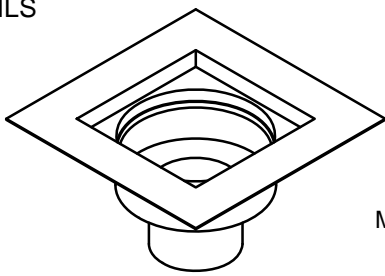
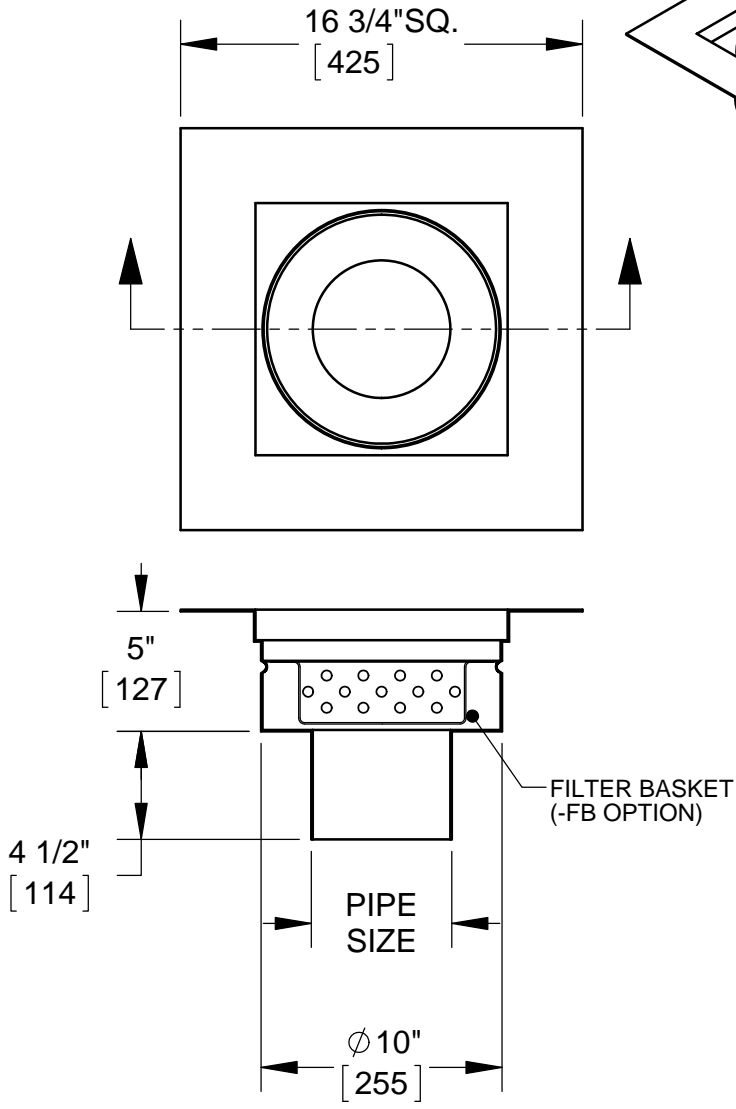

STANDARD GRATE
PERFORATED - MEDIUM DUTY
FREE AREA = 42 IN²
MEETS ADA AND HEEL-PROOF REQS.

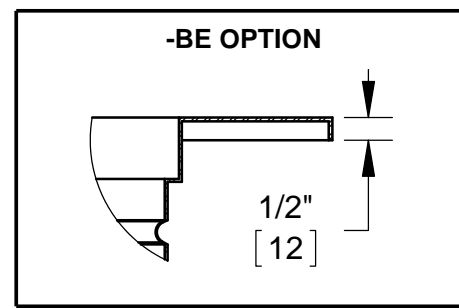
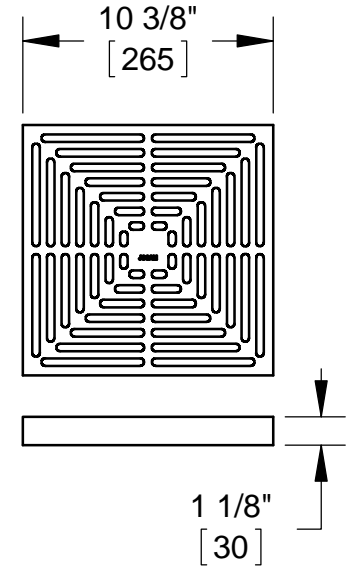

OUTLET O.D. FITS CLOSELY WITH I.D. OF NO-HUB CAST IRON PIPE

	PIPE SIZE	OUTLET O.D.
	2"	1.87 [47.5]
	3"	2.87 [72.9]
	4"	3.85 [97.8]
	6"	5.85 [148.6]
	8"	7.81 [198.4]

OPTIONS:

-FB	FILTER BASKET (41600-FB)
-SB	SEDIMENT BUCKET (41600-SB)
-NG	NO GRATE
-HG	PERFORATED HALF GRATE
-3Q	PERFORATED 3/4 GRATE
-MG	MESH, ANTI-SLIP GRATE
-LG	LADDER GRATE
-SG	PERIMETER SLOT GRATE
-316	TYPE 316L MATERIAL
-BE	BENT EDGE ON FLANGE

DATE OF LAST CHANGE: 04/26/16

DIMENSIONS ARE SUBJECT TO MANUFACTURERS TOLERANCES AND CHANGE WITHOUT NOTICE. WE CAN ASSUME NO RESPONSIBILITY FOR USE OF SUPERSEDED OR VOID DATA.

JOSAM COMPANY
MICHIGAN CITY, INDIANA

NOTES