



# siteboss cabinet<sup>TM</sup>

Operational and maintenance manual

Suitable for: SB48



Find us on social media:



## UK Head Office

Unit 14-16, Standard Way, Fareham Industrial Park, Fareham, Hampshire, PO16 8XB  
+44 (0) 23 9238 0280 | [sales@armorgard.co.uk](mailto:sales@armorgard.co.uk) | [www.armorgard.co.uk](http://www.armorgard.co.uk)

## France Office

+ 33 (0) 4 81 16 06 69  
[commercial@armorgard.fr](mailto:commercial@armorgard.fr)  
[www.armorgard.fr](http://www.armorgard.fr)

## Australia Office

+61 (0) 1300 131 751  
[sales@armorgard.com.au](mailto:sales@armorgard.com.au)  
[www.armorgard.com.au](http://www.armorgard.com.au)

## New Zealand Office

0800 826 828  
[sales@armorgard.co.nz](mailto:sales@armorgard.co.nz)  
[www.armorgard.co.nz](http://www.armorgard.co.nz)

## North America Office

1-877-794-2848  
[info@armorgardusa.com](mailto:info@armorgardusa.com)  
[www.armorgardusa.com](http://www.armorgardusa.com)

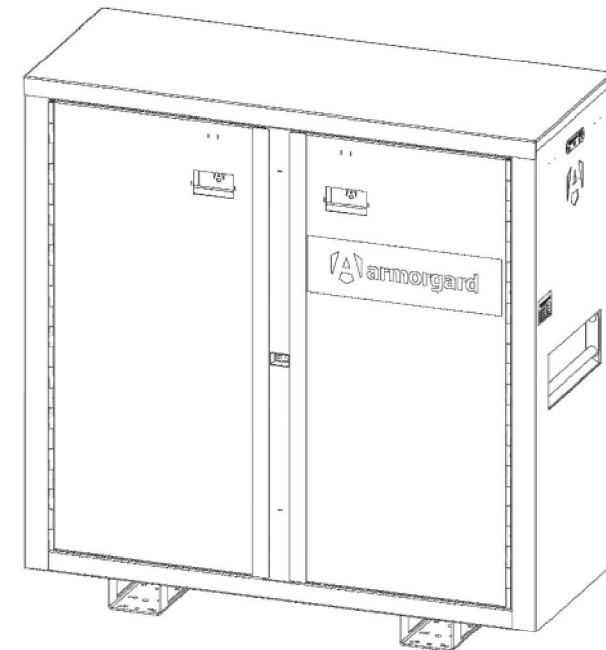

1-877-794-2848 >> [info@armorgardusa.com](mailto:info@armorgardusa.com)



# Welcome

Welcome to your Armorgard SiteBoss Cabinet. Pioneering jobsite security and usability, this cabinet is built to last and built to protect. Please consult this manual for instructions on how to get the most from the unit.

**Please read this operational and maintenance manual carefully prior to setting up the SiteBoss Cabinet. Always keep this manual with the product and read prior to use.**

---

## Spare parts



Replacement casters



Replacement shelves

**Other spare parts available. Please get in touch for more information.**



1.4.1 Defect Arises Because the Buyer Failed to Follow the Seller's Oral or Written Instructions as to the Storage, Installation, Commissioning, Use or Maintenance of the Goods or (if There Are None) Good Trade Practice;

1.4.2 the Buyer Alters or Repairs the Goods Without the Written Consent of the Seller;

1.4.3 Defect Arises From Fair Wear and Tear (as Determined by the Seller in Its Sole and Absolute Discretion), Cosmetic Rust, Scratches, Dents, or Willful Damage, Negligence, Abnormal Working Conditions or Misuse, Environmental or Other External Factors;

1.4.4 the Buyer Makes Any Further Use of the Goods After Giving Notice of a Defect in Writing to the Buyer;

1.4.5 Defect Arises as a Result of the Seller Following Any Drawing, Design or Specification Supplied by the Buyer;

1.4.6 the Defect or Imperfection is of a Minor or Insignificant Nature in Respect of the Goods; or

1.4.7 the Goods Differ From Their Description or Specification as a Result of Changes Made to Ensure They Comply With Applicable Statutory or Regulatory Requirements.

1.5 Subject to Section 1.3 and 1.4 and the Seller's Right to Examine Such Goods, if Any of the Goods Do Not Comply With the Warranty in Section 1.1, the Seller's Liability Shall Be Limited (at the Seller's Option) to the Repair or Replacement of Such Goods (or the Defective Part(S) in Question) or the Refund of the Price (or a Proportionate Part of the Price), and the Seller Shall Have No Further Liability to the Buyer.

1.6 if the Seller So Requests, the Buyer Shall, at the Seller's Expense, Return the Goods or the Defective Part(S) in Question to the Seller. Any Goods Replaced Will Belong to the Seller and Any Repaired or Replacement Goods Will Be Guaranteed on These Terms.

1.7 the Remedies Set Forth in This Section 1 Shall Be the Buyer's Sole and Exclusive Remedy and the Seller's Entire Liability for Any Breach of the Limited Warranty Set Forth in Section 1.1.

# Contents

Safety information.....	4
Product specification.....	5
What's included.....	6
Tools you'll need.....	7
Getting to know your SiteBoss Cabinet.....	8
Padlock housing dimensions.....	9
How to use.....	10
Installing the padlock.....	11
Installing the rubber grommet.....	12
Electrical safety information.....	13
How to use the lock.....	14
Optional extras.....	15
Installing the casters.....	16
Attaching the crane lifting eye kit.....	17
Storing the unit.....	18
Transporting the unit.....	19
Equipment care & ongoing maintenance.....	20
Warranty.....	21
Spare parts.....	23



## Safety information

- » Before using a SiteBoss Cabinet, ensure any relevant risk assessments are carried out. Armorgard cannot be responsible for accidents that occur due to negligence.
- » Ensure that the SiteBoss Cabinet is not damaged before using it.
- » Always lock the unit and the casters when not in use or out of sight. Do NOT leave keys inside the unit while locking.
- » Do not put hands, arms or legs near the unit opening while closing the doors.
- » Improper dangerous activities performed using the SiteBoss Cabinet increases the risk of personal injury, please follow the stated instructions to prevent incidents.
- » Ensure weight is evenly distributed and that heavier items are ALWAYS loaded in the base.
- » When casters are unlocked, the unit must always be positioned on a flat, level surface. Ensure casters are locked when the cabinet is not being moved.
- » You must close doors before putting the cabinet in motion, for stability and to prevent content and product damage.
- » If casters are being installed, these must be installed according to our specification and should be checked regularly to ensure they are still fit for purpose.
- » This product should not be used for transporting or storing explosives, hazardous wastes, flammables or hazardous materials such as gas tanks, containers of solvents, dynamite, gunpowder, etc.
- » Any alteration to or unintended use of this product could create a danger of an explosion or other hazardous conditions that can result in serious personal injury, property damage or even death.
- » Only position the SiteBoss on stable and even ground to prevent it rolling over and causing injury or personal harm.
- » Do not exceed shelf capacity of 300 lbs.

## Warranty

Armorgard products are built to last, and all have a manufacturer's warranty of seven years - please refer to the terms and conditions for what this covers.

Do not force entry into the product, as this could affect the warranty. Contact your padlock distributor if you require a replacement lock or key.

### 1 Limited Warranty

1.1 the Seller Warrants to Buyer That for a Period of Seven (7) Years From the Delivery of the Goods ("warranty Period"), Such Goods Will Materially Conform to the Seller's Published Specifications at the Time of Delivery and Will Be Free From Material Defects in Workmanship.

1.2 Except for the Limited Warranty Set Forth in Section 10.1, the Seller Makes No Warranty Whatsoever With Respect to the Goods, Including Any (a) Warranty of Merchantability; (B) Warranty of Fitness for a Particular Purpose; (C) Warranty of Title; or (D) Warranty Against Infringement of Intellectual Property Rights of a Third Party; Whether Express or Implied by Law, Course of Dealing, Course of Performance, Usage of Trade or Otherwise.

1.3 Products Manufactured by a Third Party ("third Party Product") May Constitute, Contain, Be Contained in, Incorporated Into, Attached to or Packaged Together With, the Goods. Third Party Products Are Not Covered by the Limited Warranty in Section 1.1. for the Avoidance of Doubt, the Seller Makes No Representations or Warranties With Respect to Any Third Party Product, Including Any (a) Warranty of Merchantability; (B) Warranty of Fitness for a Particular Purpose; (C) Warranty of Title; or (D) Warranty Against Infringement of Intellectual Property Rights of a Third Party; Whether Express or Implied by Law, Course of Dealing, Course of Performance, Usage of Trade or Otherwise.

1.4 the Seller Shall Not Be Liable for a Breach of the Limited Warranty in Section 10.1 if the:



## Equipment care

The SiteBoss Cabinet is weather resistant and finished with a durable powder coating, so it is suitable for outdoor use, however, it does not mean it is waterproof. It is always important to note that any electrical components or equipment susceptible to water damage should be sealed.

Always ensure that the product data plate remains visible and in good condition, especially the unique serial number.

## Ongoing maintenance

It is important to check that the SiteBoss Cabinet is not damaged before every use.

We recommend for you to check the doors, locks, shelves and hinges every three months, to ensure that the SiteBoss Cabinet can operate fully. If the SiteBoss Cabinet will be under rigorous use, we recommend integrity checking regularly.

Always carry out integrity checks before lifting the unit.

Apply light oil to hinges for smoother operation.

- » Only use UL or CSA listed electrical devices that meet the requirements of the local jurisdiction
- » Always wear the appropriate PPE for the task you are performing, as outlined in your risk assessment or safe work practices.
- » The unit has an overall WLL of 2200 lbs.

**While every effort has been made to ensure this operational and maintenance manual covers every aspect needed to operate your product safely, please take care when using the product and always operate with caution. Always liaise with management personnel on site for any additional operational restrictions that you need to be aware of.**

Do	Don't
✓ Lock the unit when leaving it unattended	✗ Leave keys inside unit when locking
✓ Keep opening clear when closing doors	✗ Ever let cabinet become unstable
✓ Integrity check the unit before lifting	✗ Use unit to store hazardous substances
✓ Fully unload before lifting	✗ Leave casters unlocked when in position

## Product specification

Product code	Description	Weight (lbs)	External Dimensions W x D x H (inches)	Internal Dimensions W x D x H (inches)
SB48	Site Cabinet	517	60.2 x 24.6 x 60.6	59.8 x 20.9 x 56.9

SiteBoss™ Patent 2211899.6



## What's included...



1x SiteBoss Cabinet

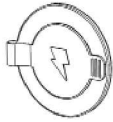

1x rubber grommet

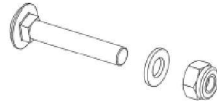

1x UltraLock fixing kit  
(padlock not included)



3x shelves

## Transporting the unit

The design of the SiteBoss Cabinet makes transporting the product easy.

The units come with forklift pockets for transporting using a forklift or pallet truck. Optional casters and crane lifting eyes can be installed to these units using the pre-drilled holes.

Please note that units are heavy may require assistance to lift, and it is always advised to lift the units when they are empty of contents.

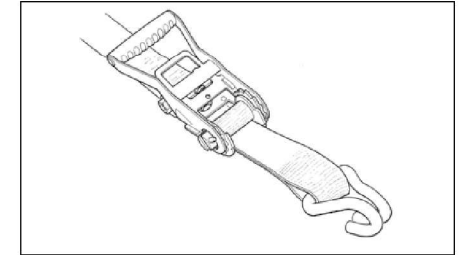
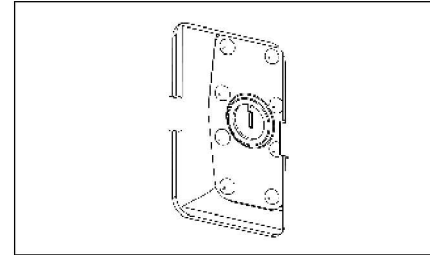

- 1.** Always secure the lock and remove key before lifting the unit, to ensure that the lid does not open unexpectedly. Do not leave the key inside the padlock.
- 2.** When transporting, ensure the unit is secured using straps or other necessary measures.



## Storing the unit

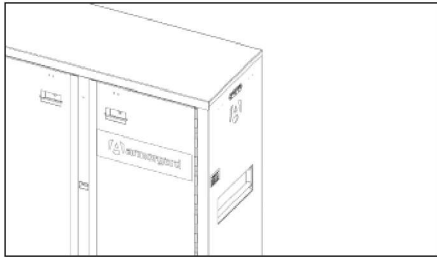

- 1.** The flat sides and recessed handles of the SiteBoss Cabinet can help save space when storing the unit.

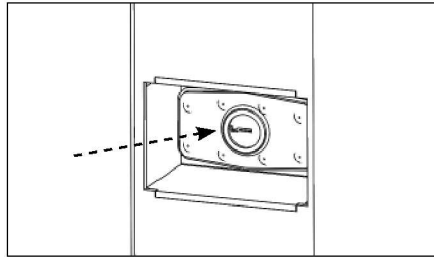

- 2.** Ensure that the lock is secured when leaving the SiteBoss Cabinet unattended. This is essential to maintain the maximum security of the unit.

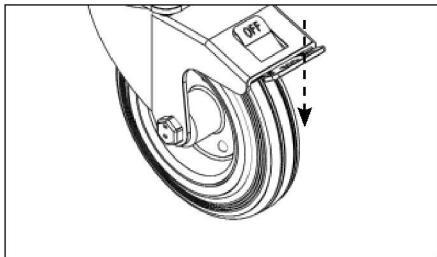

- 3.** When the SiteBoss Cabinet is in position, always ensure the caster brakes are used.

## Tools you'll need...



- »  
Adjustable wrench or ratchet and socket (11/16" socket for installing padlock and 1/2" socket for casters)



- »  
Rubber mallet or hammer (for adding rubber grommet)



- »  
One person required



## Getting to know your SiteBoss Cabinet™

Pioneering jobsite security and usability, this cabinet is built to last and built to protect

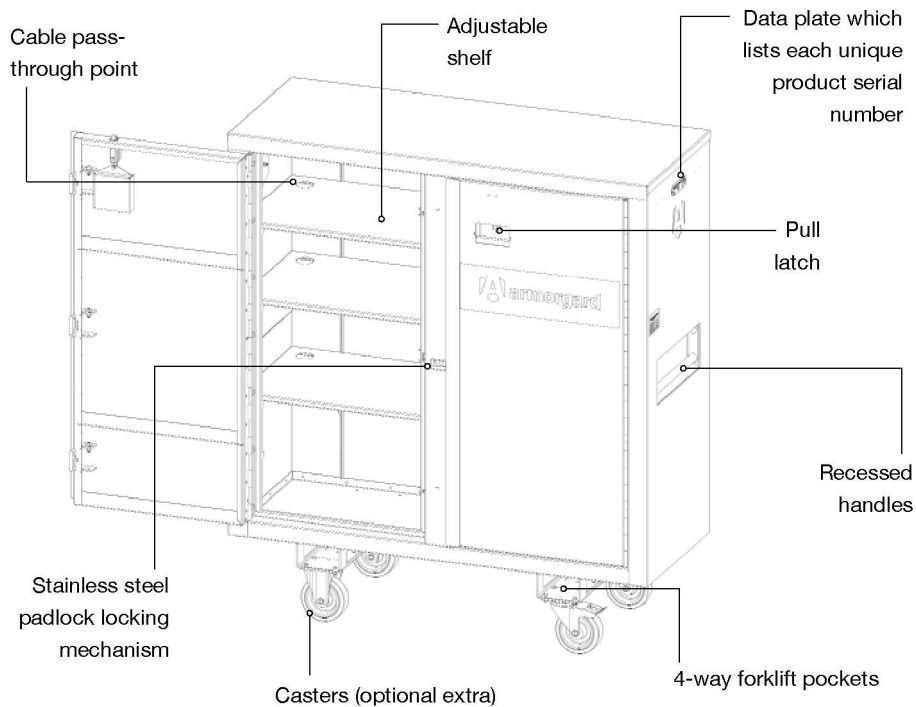

UltraLock



Forklift skids



Suitable for use on-site



Product with handles



» Video: how to attach the crane lifting eyes

## Attaching the crane lifting eye kit (optional extra)

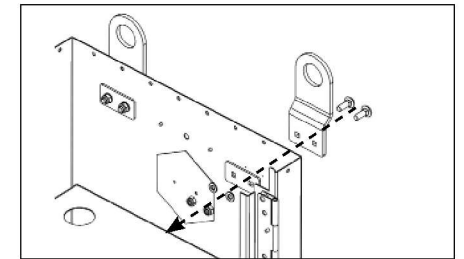
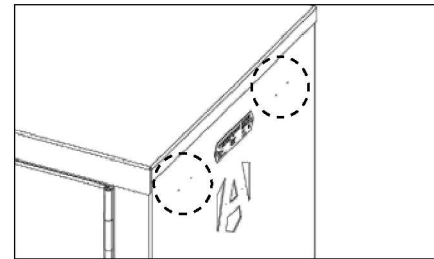

1. For the SiteBoss Cabinets that can be attached with crane lifting eyes, use a 13/32" metal drill bit to drill out the four pilot holes located on each side of your SiteBoss Cabinet.
2. Thread the coach bolts through the lifting eyes, then back through the unit. Inside the unit, add a backing plate, washers and nylocks to each bolt as shown.

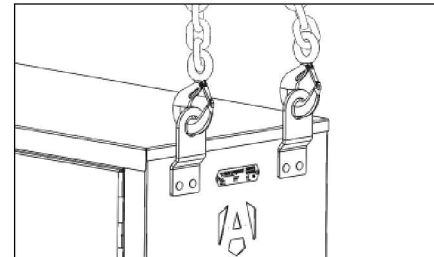

3. Always check the working load limit of the product before carrying out a lift.

**Before lifting, a risk assessment must be performed by a qualified person to ensure the product is safe to lift.**





»  
Video: how to attach  
the casters

## Attaching the casters (optional extra)

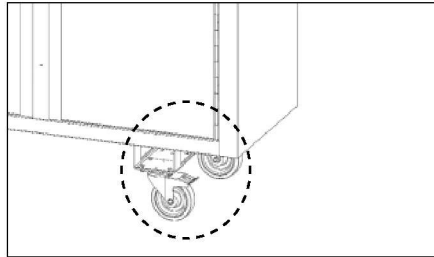
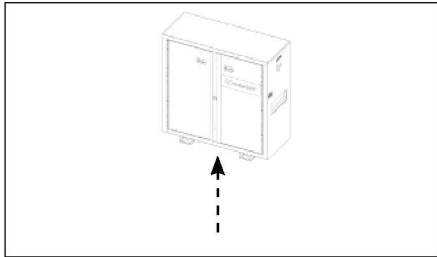

1. For the SiteBoss Cabinets that can be installed with casters, lift the unit on to a stable platform to ensure it does not roll and cause injury. The unit **MUST** be empty when installing casters.

2. Armorgard caster kits come with two swivel casters and two swivel-braked casters. We recommend attaching the braked casters on the same side.

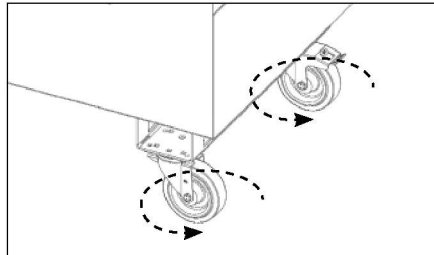
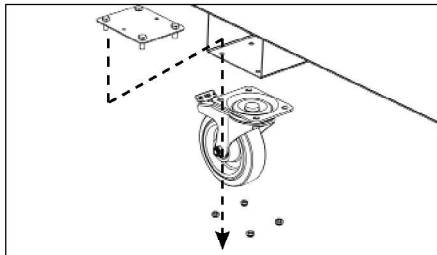

3. Insert the caster plate and tighten the nuts from the bottom using the adjustable wrench.

4. Repeat step three for the other casters. Once complete, check all nuts are tight, and then ensure the casters can swivel 360° before lowering the SiteBoss Cabinet.

## Padlock housing dimensions

This lock system is designed to be used with a Master Lock No. 1, Master Lock No. 5, ABUS 41/50 or American Lock No. 50, or an equivalent sized lock. If you are using a padlock not listed above, it is your responsibility to make sure the lock mechanism is working correctly. Padlocks must meet ALL requirements listed in diagram.

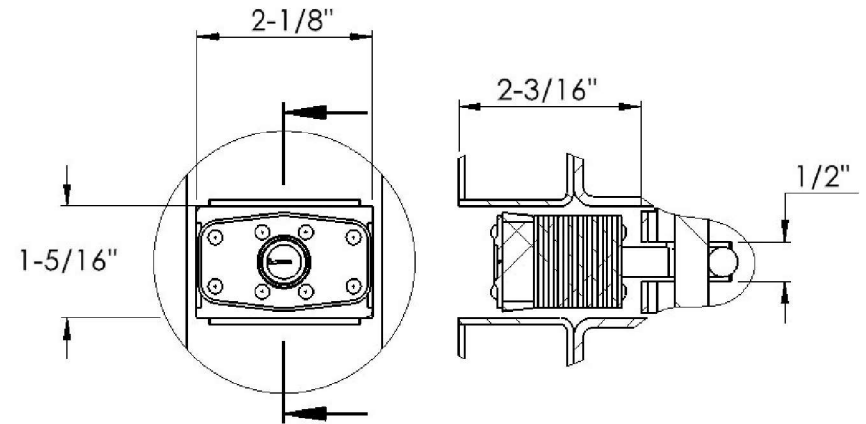

**Padlock not included**



## How to use

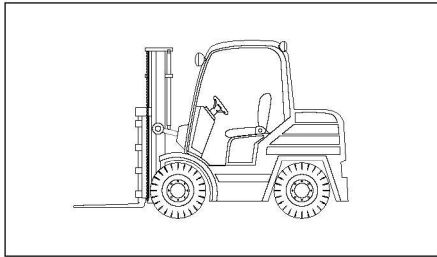

- 1.** You may require a forklift or pallet truck when unloading your SiteBoss Cabinet.

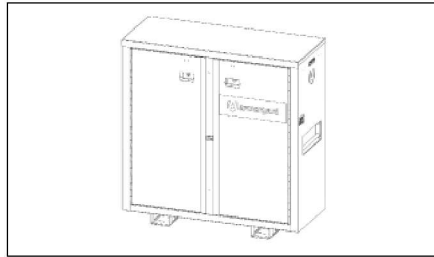

- 2.** The SiteBoss Cabinet units arrive assembled. The upper shelves have fixed locations and the lower shelf can be installed in either of two positions.

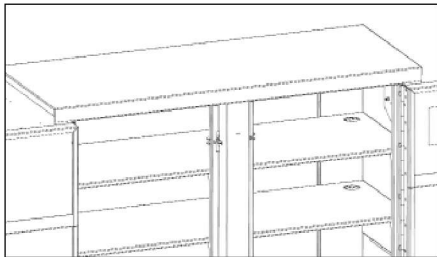

- 3.** It is important to check that the product is not damaged upon arrival and all parts are intact.

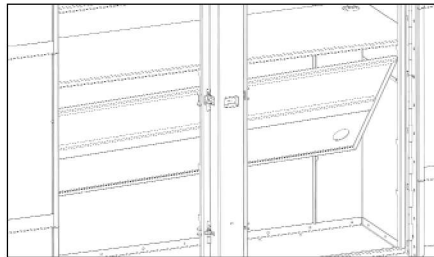

- 4.** To adjust the shelves, tilt them at an angle and pivot off the brackets.

## Take your SiteBoss Cabinet™ to the next level with these optional extras

Contact the Armorgard team to find out more about the optional extras for your product.



### Casters

To make your SiteBoss Cabinet mobile



### Crane lifting eyes

To transport by crane



## How to use the lock

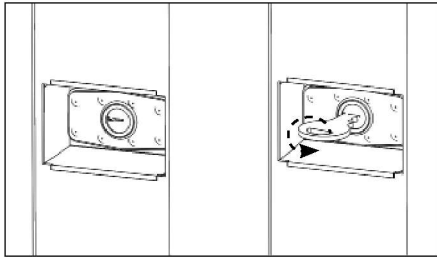

1. Once the padlock is installed, to unlock the unit, you will need to insert the key into the padlock. Twist it as normal, and this will unlock the door.

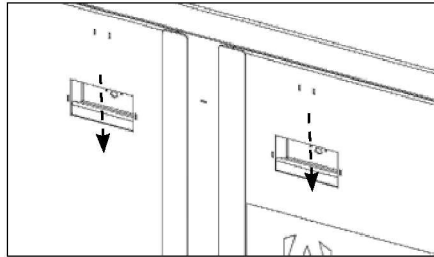

2. Push down on the pull latch to release and open the door.

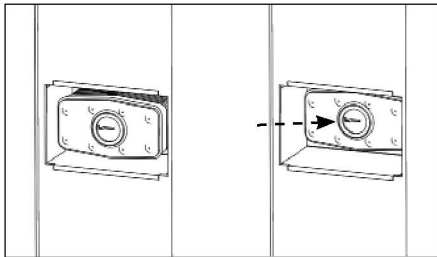

3. To lock your product, you must close the doors and simply push the padlock in. Always double check that the locks are properly secured before leaving unattended.



»  
Video: how to install  
the padlock

## Installing the padlock

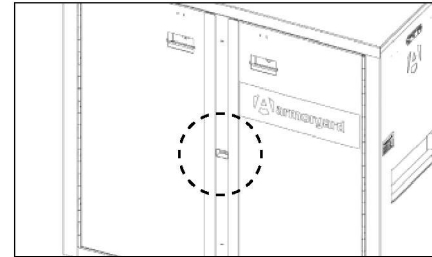

1. To fit the padlock, locate the cavity where it will be installed.

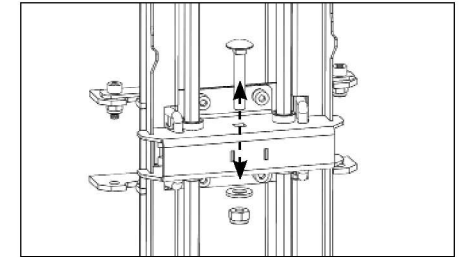

2. Inside the product, on the back of the cavity (between both doors) there will be a bolt with a nut. Remove nut and bolt to allow access for the padlock.

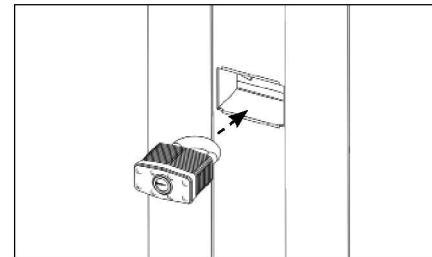

3. Insert the shackle of the padlock inside the cavity horizontally. The keyhole should remain accessible from the front face.

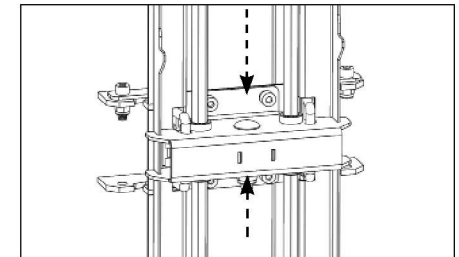

4. Once the padlock is inserted, return the bolt into its original place, and use the nut to secure it all together. Always check that the lock is in correct working order after installing, before the door is closed.



» Video: how to install the rubber grommet

## Installing the rubber grommet

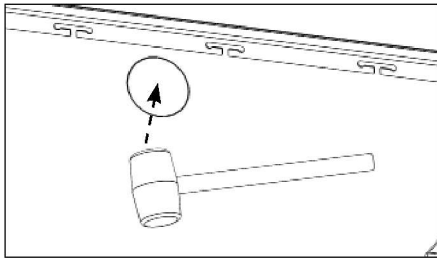

**1.** There are two cut-out plates in the unit. Decide which is the most suitable for the intended use. Once located, using a rubber mallet, carefully knock the cut-out plate from the inside.

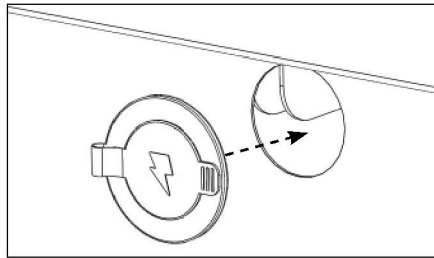

**2.** Next, take the rubber grommet and place it from the outside to fit the cut-out. Ensure it is properly installed and no sharp edges are exposed.

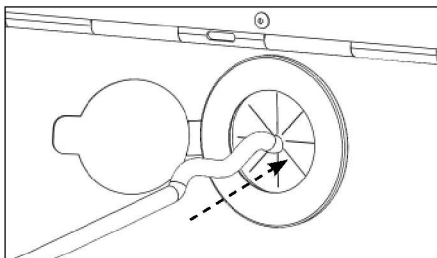

**3.** When passing cords through the grommet, insert them from the outside.

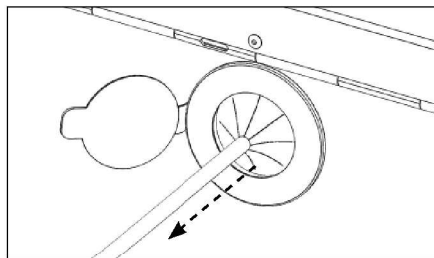

**4.** After inserting, pull 2-3" of the cord back to make sure rubber fins are pointing out the box.

## Electrical safety information

All electrical work **MUST** be performed properly with safety precautions. To prevent injury or damage to property, please ensure the below information is read carefully. Only use UL or CSA listed electrical devices that meet the requirements of the local jurisdiction.

### Extension cords

- » Ensure that manufacturer's instructions and safety information are always followed.
- » Never use a damaged cord. Always check before using.
- » Always insert cords after the rubber grommet is safely in place.
- » You must not overload the extension cord.
- » You must only use cords that are designed for outdoor use.
- » Prior to transporting the unit, ensure all cords have been removed from the grommet.
- » Extension cords must not be connected to outlet that also supplies critical safety equipment.
- » Always use UL certified products/accessories.

### Cordless battery chargers

- » Ensure that manufacturer's instructions and safety information are always followed. Chargers and batteries must be cared for properly following manufacturer's guidelines.
- » Place electrical components on shelf (if applicable).
- » If electrical components become wet or exposed to hazardous and flammable substances, switch off and discontinue use immediately.
- » Always check chargers and batteries will operate properly and are not damaged.
- » Do NOT come into contact with metal prongs when plugging or unplugging electrical components.
- » Electrical components must be kept away from flammable and hazardous substances.
- » Only place suitable jobsite equipment in the unit.