

RETROFIT SAFETY RAILING SYSTEM

Installation and Maintenance Instructions

These are recommended guidelines. Locally accepted and/or mandated regulations and codes must be followed in addition to these instructions.

Required Tools

- 9/16" Open End Wrench
- 9/16" Hexagonal Socket
- Socket Driver or Impact Driver
- Only for Hatches without pre-drilled holes
- 7/16" Drill, 1/8" Drill
- Drill Driver
- Phillips Head Driver Bit

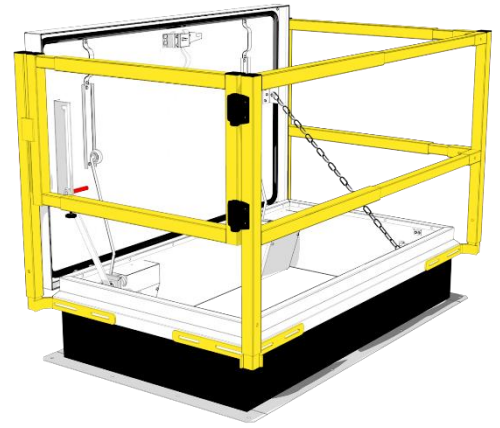

COMPONENTS INCLUDED:



(A) F-Frame Post - QTY 2



(B) Tree Post - QTY 1



(C) Single Post - QTY 1



(D) Corner Bracket - QTY 4



(E) Short Rail - QTY 2

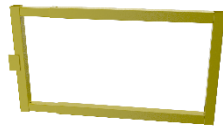

(F) Gate - QTY 1

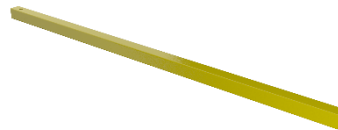

(G) Long Rail - QTY 2



(H) Square Tube Plug - QTY 6

(I) 3/8-16 x 2.5" Bolt - QTY 8

(J) 3/8 Washer - QTY 8

(K) 3/8 Locknut - QTY 8

(L) 3/8-16 x 1" - QTY 16

(O) Self Drill Screws - QTY 8

(P) Clip On Nuts - QTY 8



(M) Locking Knob - QTY 1



(N) Hinge - QTY 2

5030 Corporate Exchange Blvd SE
Grand Rapids, MI 49512
(800) 624-8642 | milcorinc.com

MILCOR[®]

Exploded Assembly View:

Note: For reference only. Continue reading assembly instructions for proper steps.

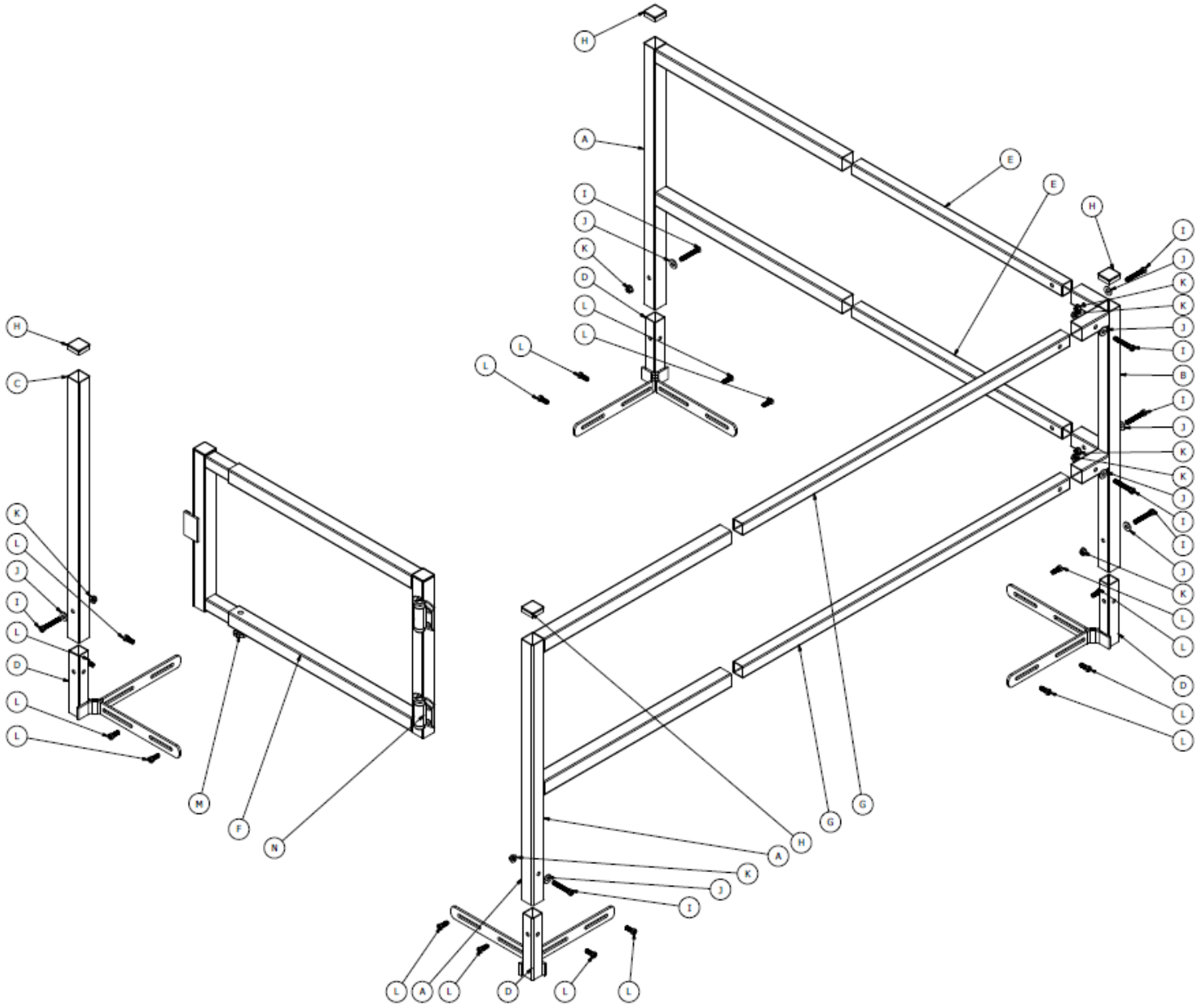

5030 Corporate Exchange Blvd SE
Grand Rapids, MI 49512
(800) 624-8642 | milcorinc.com

MILCOR®

Overview: The Retrofit Safety Rail system is designed for use as a safety accessory to an existing roof hatch. It is universal to fit Curbs from 48" to 70" in length.

Note: Assembly instructions for arrangement shown on cover page. For flipped orientation, or mirrored orientation, rotate assembly as needed.

Side Rail Installation:

- Remove all components from the packaging and be sure you have everything listed above.
- Position Corner Bracket (D) to Curb (Figure 1).
- The Corner Bracket (D) includes pilot-hole slots. If slots align with holes already in the curb proceed to Step 4.
 - Position Curb Bracket (D) to Curb with lower edge flush with bottom of Curb cap (Figure 1).
 - Use slots in Corner Bracket (D) as a template to mark hole locations. Use 7/16" bit to drill any required holes (4 bolts required for each Corner Bracket) (Figure 1).
- Clip-On Nuts (P) are provided to improve speed and ease of installation.
 - Install Clip On nut on each mounting hole.
- Secure Corner Bracket (D) to Curb cap. Install 3/8"x1" Bolts (L) through hole slots in Corner Bracket (D), through the curb cap, and into the Clip On Nut (or Flange Nut)
 - Note: Hand tighten all bolts until assembly is complete.
- Repeat Steps 2-5 for all four corners
- Install Single Post (C) into front-left Corner Bracket (D). Secure with 2.5" Bolt (I), Washer (J), and Locknut (K) using a 9/16" wrench and socket driver. Align post to be vertical. Tighten all fasteners.
- Install one F-Frame Post (A) into back-left Corner Bracket (D). Secure with 2.5" Bolt (I), Washer (J), and Locknut (K) using a 9/16" wrench and socket driver. Do not fully tighten.
- Insert a Short Rail (E) into each installed F-Frame Post (A) female rail, leaving the end with thru-hole exposed and parallel to roof. These holes will be used to attach to next post.
- Install Tree Post (B) into back-right Corner Bracket (D) with female inserts pointing towards corners of hatch. Secure with 2.5" Bolt (I), Washer (J), and Locknut (K) using a 9/16" wrench and socket driver. Do not fully tighten.
- Attached pre-inserted Short Rails (E) into the two female inserts on Tree Post (B). Secure with 2.5" Bolt (I), Washer (J), and Locknut (K) using a 9/16" wrench and socket driver. Do not fully tighten.
- Insert a Long Rail (G) into each female rail on not installed F-Frame (A), leaving the end with thru-holes exposed.
- Install second F-Frame (A) with inserted Long Rails (G) into front-right Corner Bracket (D). Secure with 2.5" Bolt (I), Washer (J), and Locknut (K) using a 9/16" wrench and socket driver. Do not fully tighten.
- Attached pre-inserted Long Rails (G) into the two female inserts on Tree Post (B). Secure with 2.5" Bolt (I), Washer (J), and Locknut (K) using a 9/16" wrench and socket driver. Do not fully tighten.
- Use 9/16" wrench and socket driver to tighten all fasteners.
- Install Square Tubing Plugs (H) into top four opening of vertical posts (A, B, C).

Figure 1:
Corner Bracket Positioning

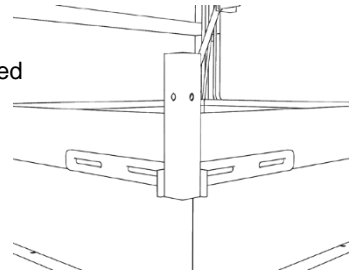

Gate Installation:

It is important to note that the gate can be configured for both left and right hand operation depending on which side of the gate the hinges are mounted to (front/back), and which side of the railing system the hinges are attached. The locking knob MUST always end up on the bottom portion of the gate. The assembly will need to be taken apart and the half with the locking knob flipped to make the change from LH to RH.

- Install Square Tubing Plug (H) in the top 2 openings of the Gate (F).
- Use Hinge (N) as template for marking holes on the Gate (F).
- Install Hinge (N) 2" from the top and bottom of gate and mark holes (**Figure 1**).
- Drill marked holes with 1/8" drill.
- Use the provided Self-Drilling Screws (O) to attach hinges to gate.
- With both Hinges (N) installed on Gate (F) the top hole can be marked on the front-right F-Frame Post (A).
- Hold the Gate (F) flush with the top of the F-Frame Post (A). (**Figure 2**).
- Mark the upper hole with 1/8" drill. Drill into post.
- Install first Self-Drilling Screw (O).
- Rotate the Gate (F) until it is flush with the top of the Single Post (C) on the front-left side of the hatch.
- Mark the remaining holes and drill with 1/8" drill.
- Install remaining Self-Drilling Screws (O) through Hinges (N).
- Adjust length of Gate (F) so the stop plate engages with the Single Post (C).
- Tighten position with Locking Knob (M). (**Figure 2**).
- Adjust spring tension in Hinges (N) so the gate closes without assistance.
 - See instructions included with Hinges (N) for adjustment procedure.

Figure 1: Locating First Hinge

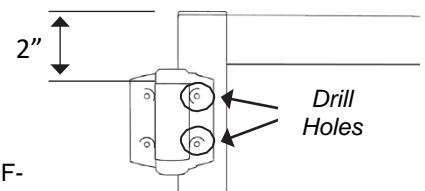
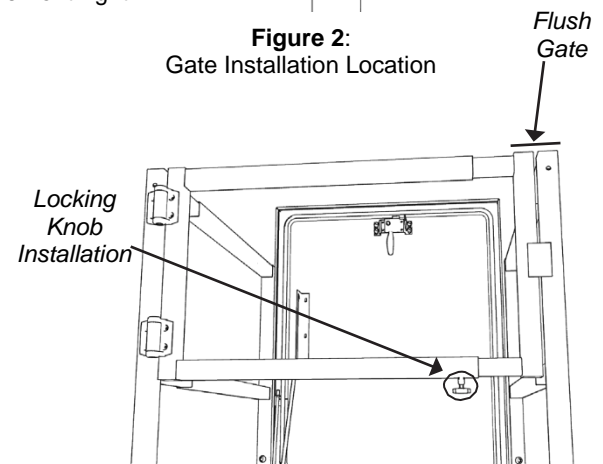

Figure 2:
Gate Installation Location



Maintenance:

The fasteners for the Retrofit Railing System are of corrosion-resistance construction and should be regularly inspected and tightened.