

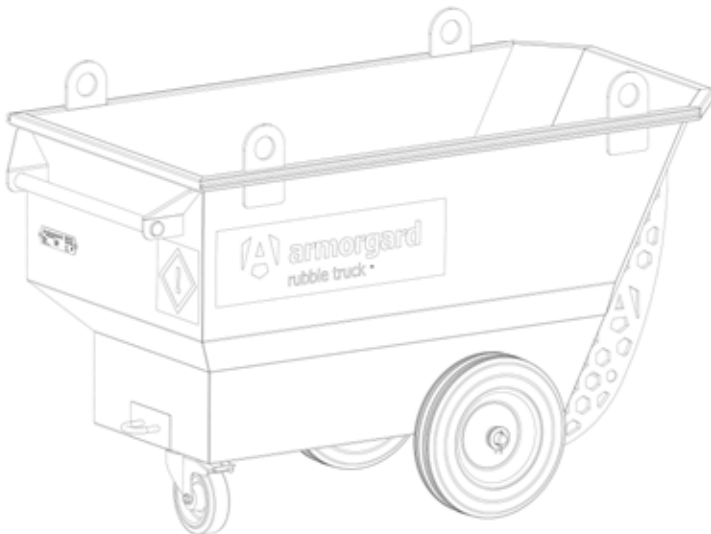

rubble truckTM

Operational and maintenance manual

Suitable for: RT400



1-877-794-2848 >> info@armorgardusa.com



Welcome

Welcome to your Armorgard Rubble Truck. The multi-purpose Rubble Truck is ideal for handling waste and rubble, featuring a huge 14 cu ft. basin. Please consult this manual for instructions on how to get the most from the unit.

Please read this operational and maintenance manual carefully prior to setting up the Rubble Truck. Always keep this manual with the product and read prior to use.

Contents

Safety information	4
Product specification	5
What's included	6
Tools you'll need	7
Getting to know your Rubble Truck	8
How to use	9
Attaching the caster	10
Attaching the wheels	11
Storing the unit	12
Transporting the unit	13
Equipment care	14
Ongoing maintenance	14
Warranty	15
Spare parts	17
Notes	18



Safety information

- » Before using a Rubble Truck, ensure any relevant risk assessments are carried out. Armorgard cannot be responsible for accidents that occur due to negligence.
- » Ensure that the Rubble Truck is not damaged before using it, especially the crane lifting eyes and caster wheels.
- » When caster is unlocked, the unit must always be positioned on a flat, even surface. Ensure caster is locked when it's not being moved.
- » Always use the crane lifting eyes when lifting by crane, which can be used when fully loaded. Ensure the load is contained and unable to fall loose. Lifting via the crane lifting eyes should only be permitted by a qualified person, subject to a risk assessment.
- » Improper dangerous activities performed using the Rubble Truck increases the risk of personal injury, please follow the stated instructions to prevent incidents.
- » Caster and wheels must be installed according to our specification and should be checked regularly to ensure it is still fit for purpose.
- » Use both hands when maneuvering the Rubble Truck, taking extra care on slopes. Do not move if you do not feel comfortable doing so.
- » Keep hands clear of the edges. Failure to do so could result in severe injury.
- » This product should not be used for transporting or storing explosives, hazardous wastes, flammables or hazardous materials such as gas tanks, containers of solvents, dynamite, gunpowder, etc.
- » Any alteration to or unintended use of this product could create a danger of an explosion or other hazardous conditions that can result in serious personal injury, property damage or even death.
- » The unit has an overall WLL of 1650 lbs.
- » Always check the working load limit of the product before carrying out a lift.
- » Always wear the appropriate PPE for the task you are performing, as outlined in your risk assessment or safe work practices.
- » No passengers should be allowed on the Rubble Truck. This product is not designed or intended to transport passengers



- » Lifting hazard. Single person lift could cause injury. Use assistance when lifting.

CAUTION!

MAXIMUM LOAD

1650 LBS.

While every effort has been made to ensure this operational and maintenance manual covers every aspect needed to operate your product safely, please take care when using the product and always operate with caution. Always liaise with management personnel on site for any additional operational restrictions that you need to be aware of.

Do

- ✓ Lock the caster when leaving unattended
- ✓ Use both hands on the handle
- ✓ Integrity check unit before lifting
- ✓ Use crane lifting eyes

Don't

- ✗ Use if damaged
- ✗ Overload the unit
- ✗ Let go of handle when on a slope
- ✗ Leave caster unlocked when in position

Product specification

Product code	Description	Weight (lbs)	External Dimensions W x D x H (inches)	Internal Dimensions W x D x H (inches)
RT400	Rubble Truck	196	29.9 x 57.5 x 37.6	17.5 x 51.2 x 26

Design Registration 3380963



What's included...



1x Rubble Truck



1x caster
(with fixings)



1x caster plate



2x solid rubber wheels
(with fixings)

Tools you'll need...



Adjustable
wrench (for
adding caster)



Multiple
people may
be required
to assist
with lifting



Getting to know your Rubble Truck™

A game changer for effortlessly moving trash and rubble around jobsites

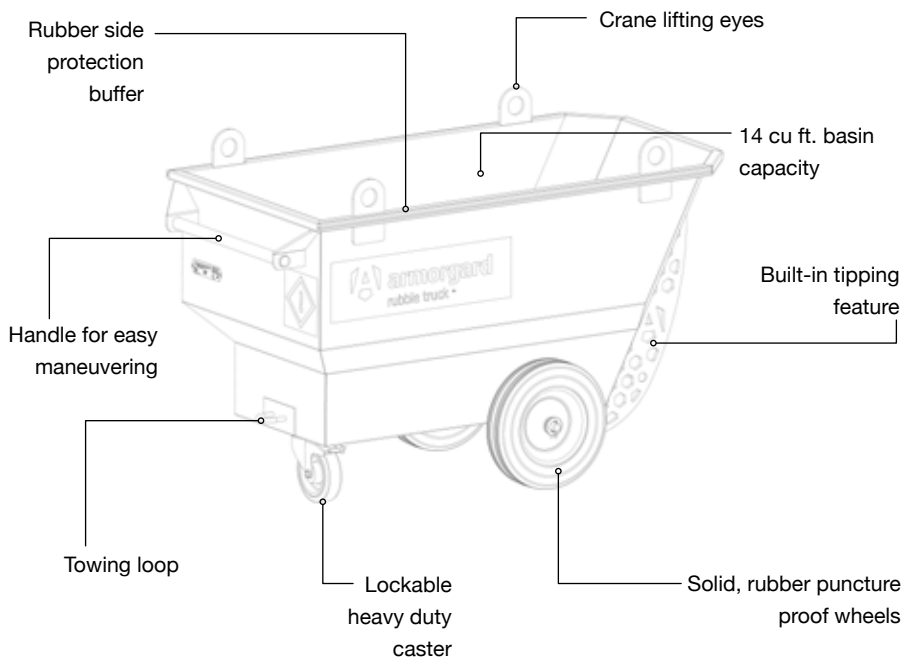

Crane lifting eyes



Heavy-duty caster



Stackable



Puncture-proof wheels



Product with handles

How to use

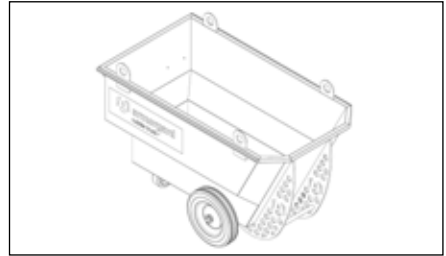
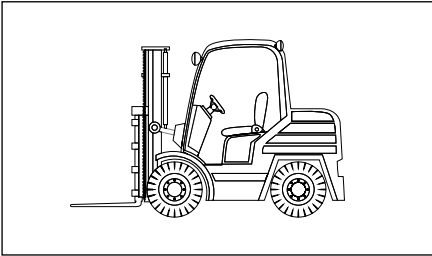

1. You may require a forklift or pallet truck when unloading your Rubble Truck. Two or more people may be required to assist with lifting.

2. It is important to check that the product is not damaged upon arrival and all parts are intact.



>>
Video: how to attach
the casters

Attaching the caster

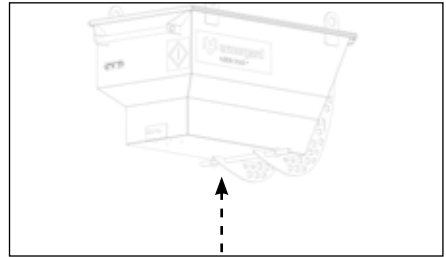
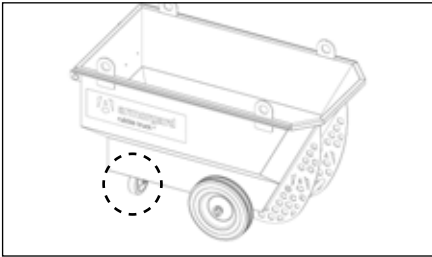

1. You will need to install the swivel-braked caster at the back of the unit.

2. Lift the unit on to a stable platform/roll onto its side to ensure it does not cause injury. The Rubble Truck **MUST** be empty when installing the caster.

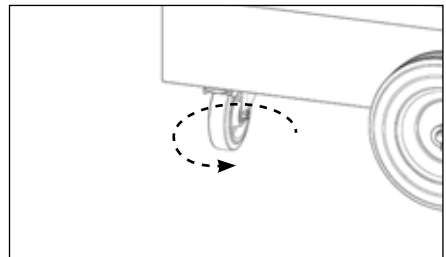
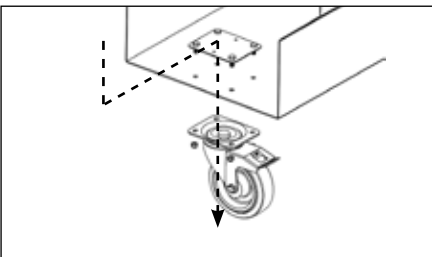

3. Insert the caster plate and tighten the nuts from the bottom using the adjustable wrench.

4. Once complete, check all nuts are fully tight, and then ensure the caster can swivel 360° before lowering the Rubble Truck.



>>
Video: how to attach
the wheels

Attaching the wheels

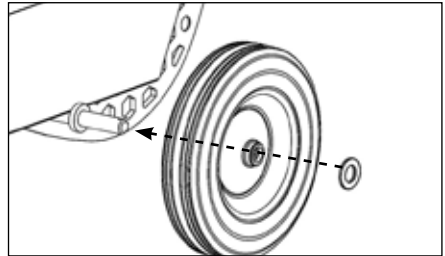
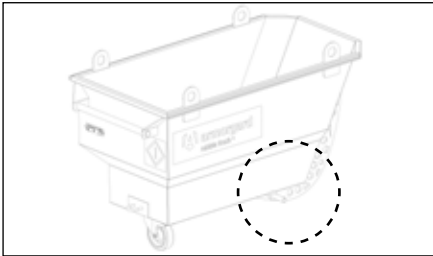

1. Locate the wheel axle found at the bottom of the unit, towards the front.

2. Insert the wheel through one of the axle edges, followed by a large washer provided.

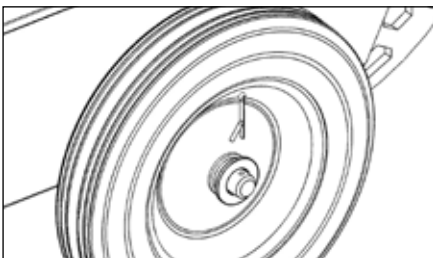

3. Use a cotter pin to secure in place. Repeat for the other wheel.



Storing the unit

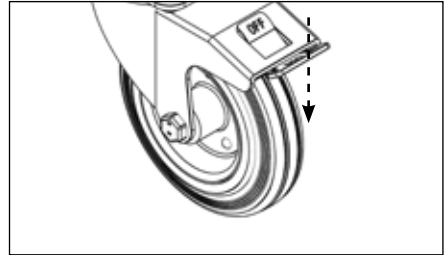
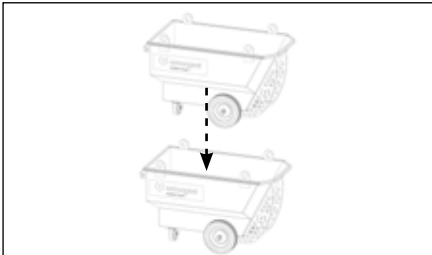

- 1.** The Rubble Truck can be stacked up to four units high to help save space when storing the unit. Always carry out a risk assessment to ensure suitable stability is reached.
- 2.** When the Rubble Truck is in position, always ensure the castor brake is used.

Transporting the unit

The design of the Rubble Truck makes transporting the product easy.

The units come with crane lifting eyes for transporting by crane. Solid, rubber puncture-proof wheels and caster helps with maneuverability even while full.

Please note that the unit may require more than one person to lift, and risk assessments should always be carried out.

Take extra care when removing a unit from a stack.

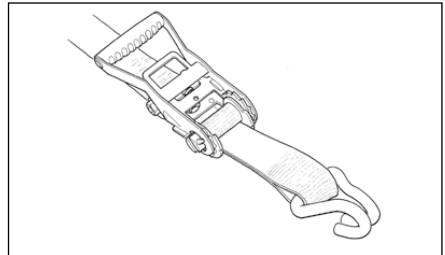
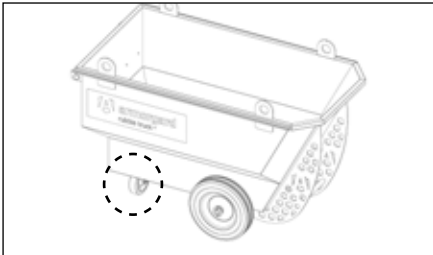

- 1.** Always secure the caster brake before transporting the unit on a vehicle.
- 2.** When transporting, ensure the unit is secured using straps or other necessary measures.



Equipment care

The Rubble Truck is weather resistant and finished with a durable powder coating, so it is suitable for outdoor use. Do not use to transport electrical components.

Always ensure that the product data plate remains visible and in good condition, especially the unique serial number.

The Rubble Truck must be inspected thoroughly before each and every use. If the condition is not suitable, the unit must not be used.

Ongoing maintenance

It is important to check that the Rubble Truck is not damaged before every use.

We recommend for you to check the caster, wheels, crane lifting eyes, handle and features every three months, to ensure that the Rubble Truck can operate fully. If the Rubble Truck will be under rigorous use, we recommend integrity checking regularly.

Always carry out integrity checks before lifting the product.

Warranty

Armorgard products are built to last, and all have a manufacturer's warranty of seven years - please refer to the terms and conditions for what this covers.

1 Limited Warranty

1.1 the Seller Warrants to Buyer That for a Period of Seven (7) Years From the Delivery of the Goods ("warranty Period"), Such Goods Will Materially Conform to the Seller's Published Specifications at the Time of Delivery and Will Be Free From Material Defects in Workmanship.

1.2 Except for the Limited Warranty Set Forth in Section 10.1, the Seller Makes No Warranty Whatsoever With Respect to the Goods, Including Any (a) Warranty of Merchantability; (B) Warranty of Fitness for a Particular Purpose; (C) Warranty of Title; or (D) Warranty Against Infringement of Intellectual Property Rights of a Third Party; Whether Express or Implied by Law, Course of Dealing, Course of Performance, Usage of Trade or Otherwise.

1.3 Products Manufactured by a Third Party ("third Party Product") May Constitute, Contain, Be Contained in, Incorporated Into, Attached to or Packaged Together With, the Goods. Third Party Products Are Not Covered by the Limited Warranty in Section 1.1. for the Avoidance of Doubt, the Seller Makes No Representations or Warranties With Respect to Any Third Party Product, Including Any (a) Warranty of Merchantability; (B) Warranty of Fitness for a Particular Purpose; (C) Warranty of Title; or (D) Warranty Against Infringement of Intellectual Property Rights of a Third Party; Whether Express or Implied by Law, Course of Dealing, Course of Performance, Usage of Trade or Otherwise.

1.4 the Seller Shall Not Be Liable for a Breach of the Limited Warranty in Section 10.1 if the:

1.4.1 Defect Arises Because the Buyer Failed to Follow the Seller's Oral or Written Instructions as to the Storage, Installation, Commissioning, Use or Maintenance of the Goods or (if There Are None) Good Trade Practice;



1.4.2 the Buyer Alters or Repairs the Goods Without the Written Consent of the Seller;

1.4.3 Defect Arises From Fair Wear and Tear (as Determined by the Seller in Its Sole and Absolute Discretion), Cosmetic Rust, Scratches, Dents, or Willful Damage, Negligence, Abnormal Working Conditions or Misuse, Environmental or Other External Factors;

1.4.4 the Buyer Makes Any Further Use of the Goods After Giving Notice of a Defect in Writing to the Buyer;

1.4.5 Defect Arises as a Result of the Seller Following Any Drawing, Design or Specification Supplied by the Buyer;

1.4.6 the Defect or Imperfection is of a Minor or Insignificant Nature in Respect of the Goods;
or

1.4.7 the Goods Differ From Their Description or Specification as a Result of Changes Made to Ensure They Comply With Applicable Statutory or Regulatory Requirements.

1.5 Subject to Section 1.3 and 1.4 and the Seller's Right to Examine Such Goods, if Any of the Goods Do Not Comply With the Warranty in Section 1.1, the Seller's Liability Shall Be Limited (at the Seller's Option) to the Repair or Replacement of Such Goods (or the Defective Part(S) in Question) or the Refund of the Price (or a Proportionate Part of the Price), and the Seller Shall Have No Further Liability to the Buyer.

1.6 if the Seller So Requests, the Buyer Shall, at the Seller's Expense, Return the Goods or the Defective Part(S) in Question to the Seller. Any Goods Replaced Will Belong to the Seller and Any Repaired or Replacement Goods Will Be Guaranteed on These Terms.

1.7 the Remedies Set Forth in This Section 1 Shall Be the Buyer's Sole and Exclusive Remedy and the Seller's Entire Liability for Any Breach of the Limited Warranty Set Forth in Section 1.1.

Spare parts



Replacement
caster



Replacement
wheels

Other spare parts available. Please get in touch for more information.



Notes

Notes



Find us on social media:



UK Head Office

Unit 14-16, Standard Way, Fareham Industrial Park, Fareham, Hampshire, PO16 8XB
+44 (0) 23 9238 0280 | sales@armorgard.co.uk | www.armorgard.co.uk

France Office

+ 33 (0) 4 81 16 06 69
commercial@armorgard.fr
www.armorgard.fr

Australia Office

+61 (0) 1300 131 751
sales@armorgard.com.au
www.armorgard.com.au

New Zealand Office

0800 826 828
sales@armorgard.co.nz
www.armorgard.co.nz

North America Office

1-877-794-2848
info@armorgardusa.com
www.armorgardusa.com