



sitestationTM

Operational and maintenance manual

Suitable for: SS2-T



Find us on social media:



UK Head Office

Unit 14-16, Standard Way, Fareham Industrial Park, Fareham, Hampshire, PO16 8XB
+44 (0) 23 9238 0280 | sales@armorgard.co.uk | www.armorgard.co.uk

France Office

+ 33 (0) 4 81 16 06 69
commercial@armorgard.fr
www.armorgard.fr

Australia Office

+61 (0) 1300 131 751
sales@armorgard.com.au
www.armorgard.com.au

New Zealand Office

0800 826 828
sales@armorgard.co.nz
www.armorgard.co.nz

North America Office

1-877-794-2848
info@armorgardusa.com
www.armorgardusa.com

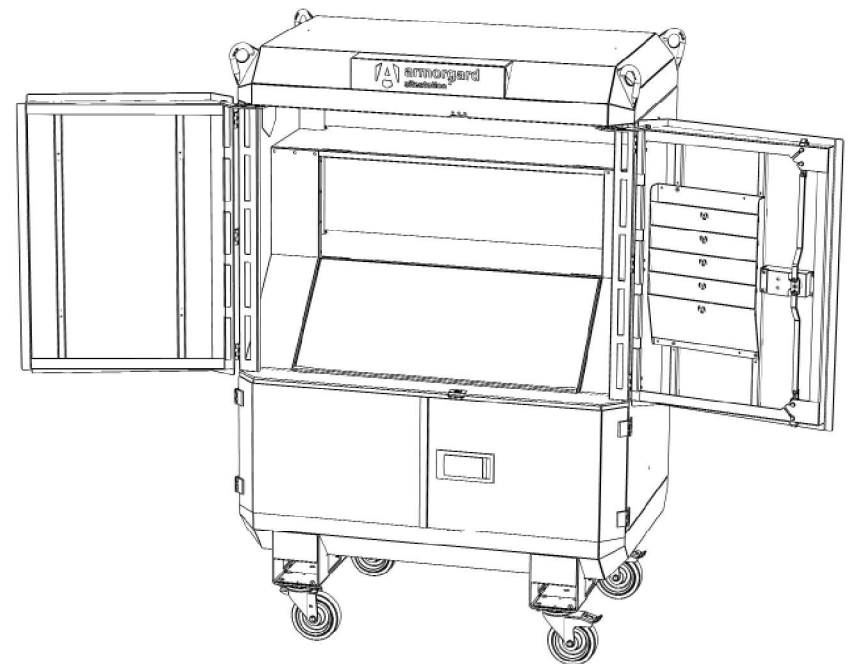

1-877-794-2848 >> info@armorgardusa.com



Welcome

Welcome to your Armorgard SiteStation. This ultimate mobile site office is the innovative replacement for your traditional desk. Please consult this manual for instructions on how to get the most from the unit.

Please read this operational and maintenance manual carefully prior to setting up the SiteStation. Always keep this manual with the product and read prior to use.

Notes



Notes

Contents

Safety information.....	4
Product specification.....	5
What's included.....	6
Tools you'll need.....	7
Getting to know your SiteStation.....	8
Padlock housing dimensions.....	10
How to assemble.....	11
Attaching the casters.....	12
Attaching the handle.....	13
Installing the rubber grommet.....	14
Electrical safety information.....	15
How to use.....	16
How to use the lock.....	17
Storing the unit.....	19
Transporting the unit.....	20
Equipment care.....	21
Ongoing maintenance.....	21
Warranty.....	22
Spare parts.....	22
Replacement parts available.....	23



Safety information

- » Before using the SiteStation, ensure any relevant risk assessments are carried out. Armorgard cannot be responsible for accidents that occur due to negligence.
- » Ensure the SiteStation is not damaged before using it.
- » Always lock the unit and the casters (if applicable) when not in use or unattended. Do NOT leave keys inside the unit while locking.
- » Do take extra care moving the unit on casters and check for uneven ground. Ensure the unit never becomes unstable.
- » When casters are unlocked, the unit must always be positioned on a flat, even surface. Ensure caster is locked when it's not being moved.
- » Any alteration to or unintended use of this product could create a danger of an explosion or other hazardous conditions that can result in serious personal injury, property damage or even death.
- » Casters must be installed according to our specification and should be checked regularly to ensure they are still fit for purpose.
- » Take care with moving parts as they may present a finger trap hazard.
- » The SiteStation must only be lifted after a thorough examination by a qualified person, with the doors closed.
- » Care should be taken to ensure contents do not make the unit top heavy. When loading, ensure weight is evenly distributed and heavier items are ALWAYS loaded in the base.
- » This product should not be used for transporting or storing explosives, hazardous wastes, flammables or hazardous materials such as gas tanks, containers of solvents, dynamite, gunpowder, etc.
- » The internal folding shelf must always be secured when in the open position, to prevent it falling shut.
- » The unit has an overall WLL of 800 lbs. Before lifting by crane, a risk assessment must be performed by a qualified person to ensure the product is safe to lift.

Notes



Spare parts



Replacement power strip



Replacement casters



Replacement light

Other spare parts available. Please get in touch for more information.

- » Always wear the appropriate PPE for the task you are performing, as outlined in your risk assessment or safe work practices.
- » When transporting, the doors must be locked shut and the product securely fastened to the vehicle.
- » Only use UL or CSA listed electrical devices that meet the requirements of the local jurisdiction.

While every effort has been made to ensure this operational and maintenance manual covers every aspect needed to operate your product safely, please take care while using the product and always operate with caution. Always liaise with management personnel on site for any additional operational restrictions that you need to be aware of.

Do

- ✓ Use rubber grommet for extension cords
- ✓ Use the light for visibility
- ✓ Take care around all finger trap areas
- ✓ Fully lock unit when not in use

Don't

- ✗ Push unit along uneven ground
- ✗ Leave keys inside unit when locking
- ✗ Hang external heavy objects from the side
- ✗ Leave trailing cables from the SiteStation

Product specification

Product Code	Description	Weight (lbs)	External Dimensions W x D x H (inches)	Internal Dimensions W x D x H (inches)
SS2-T	Mobile site station	497	55.7 x 32.7 x 78.1	Top: 51.2 x 28.3 x 41 Bottom: 51.2 x 28.3 x 24



What's included...



1x SiteStation



1x light

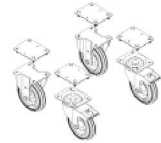

1x caster kit

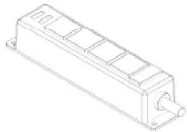

1x power strip



1x handle kit

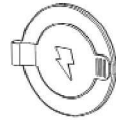

1x rubber grommet

1.4.1 Defect Arises Because the Buyer Failed to Follow the Seller's Oral or Written Instructions as to the Storage, Installation, Commissioning, Use or Maintenance of the Goods or (if There Are None) Good Trade Practice;

1.4.2 the Buyer Alters or Repairs the Goods Without the Written Consent of the Seller;

1.4.3 Defect Arises From Fair Wear and Tear (as Determined by the Seller in Its Sole and Absolute Discretion), Cosmetic Rust, Scratches, Dents, or Willful Damage, Negligence, Abnormal Working Conditions or Misuse, Environmental or Other External Factors;

1.4.4 the Buyer Makes Any Further Use of the Goods After Giving Notice of a Defect in Writing to the Buyer;

1.4.5 Defect Arises as a Result of the Seller Following Any Drawing, Design or Specification Supplied by the Buyer;

1.4.6 the Defect or Imperfection is of a Minor or Insignificant Nature in Respect of the Goods; or

1.4.7 the Goods Differ From Their Description or Specification as a Result of Changes Made to Ensure They Comply With Applicable Statutory or Regulatory Requirements.

1.5 Subject to Section 1.3 and 1.4 and the Seller's Right to Examine Such Goods, if Any of the Goods Do Not Comply With the Warranty in Section 1.1, the Seller's Liability Shall Be Limited (at the Seller's Option) to the Repair or Replacement of Such Goods (or the Defective Part(S) in Question) or the Refund of the Price (or a Proportionate Part of the Price), and the Seller Shall Have No Further Liability to the Buyer.

1.6 if the Seller So Requests, the Buyer Shall, at the Seller's Expense, Return the Goods or the Defective Part(S) in Question to the Seller. Any Goods Replaced Will Belong to the Seller and Any Repaired or Replacement Goods Will Be Guaranteed on These Terms.

1.7 the Remedies Set Forth in This Section 1 Shall Be the Buyer's Sole and Exclusive Remedy and the Seller's Entire Liability for Any Breach of the Limited Warranty Set Forth in Section 1.1.



Warranty

Armorgard products are built to last, and all have a manufacturer's warranty of seven years - please refer to the terms and conditions for what this covers.

Do not force entry into the product, as this could affect the warranty. Contact your padlock distributor if you require a replacement lock or key.

1 Limited Warranty

1.1 the Seller Warrants to Buyer That for a Period of Seven (7) Years From the Delivery of the Goods ("warranty Period"), Such Goods Will Materially Conform to the Seller's Published Specifications at the Time of Delivery and Will Be Free From Material Defects in Workmanship.

1.2 Except for the Limited Warranty Set Forth in Section 10.1, the Seller Makes No Warranty Whatsoever With Respect to the Goods, Including Any (a) Warranty of Merchantability; (B) Warranty of Fitness for a Particular Purpose; (C) Warranty of Title; or (D) Warranty Against Infringement of Intellectual Property Rights of a Third Party; Whether Express or Implied by Law, Course of Dealing, Course of Performance, Usage of Trade or Otherwise.

1.3 Products Manufactured by a Third Party ("third Party Product") May Constitute, Contain, Be Contained in, Incorporated Into, Attached to or Packaged Together With, the Goods. Third Party Products Are Not Covered by the Limited Warranty in Section 1.1. for the Avoidance of Doubt, the Seller Makes No Representations or Warranties With Respect to Any Third Party Product, Including Any (a) Warranty of Merchantability; (B) Warranty of Fitness for a Particular Purpose; (C) Warranty of Title; or (D) Warranty Against Infringement of Intellectual Property Rights of a Third Party; Whether Express or Implied by Law, Course of Dealing, Course of Performance, Usage of Trade or Otherwise.

1.4 the Seller Shall Not Be Liable for a Breach of the Limited Warranty in Section 10.1 if the:

Tools you'll need...



33/64" wrench/
adjustable wrench
(to add casters and
power strip)



43/64" wrench/
adjustable wrench
or impact driver
with 43/64" socket
(to add handle)



Rubber mallet
or hammer (for
adding rubber
grommet)



Getting to know your sitestation™

This ultimate mobile site office is the innovative replacement for your traditional desk

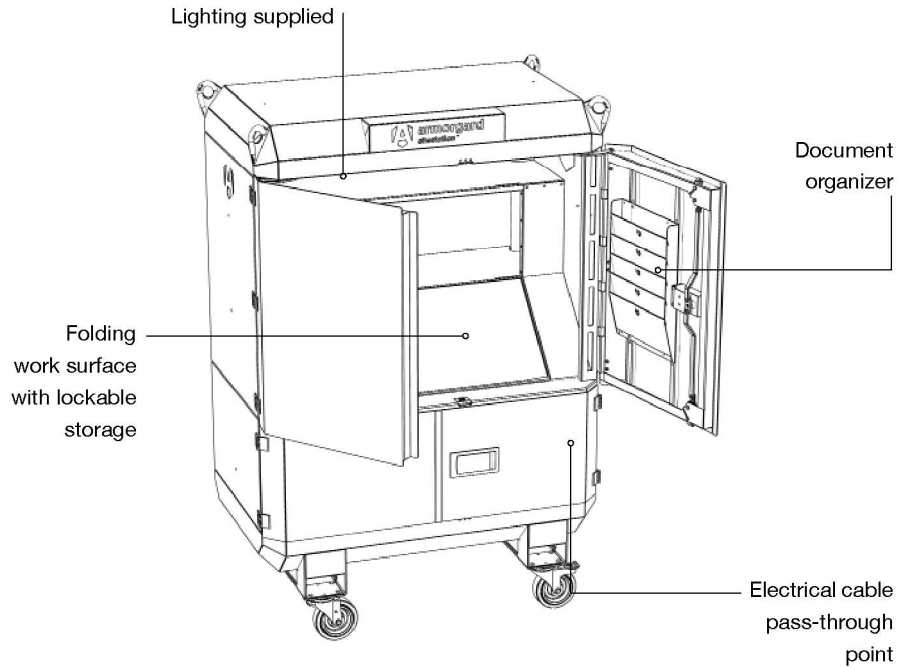

T-Latch Lock



Forklift skids



Crane lifting eyes



Heavy-duty casters



Light supply

Equipment care

The SiteStation is weather resistant and finished with a durable powder coating, so it is suitable for outdoor use, however, it does not mean it is waterproof. It is always important to note that any electrical components or equipment susceptible to water damage should be sealed, or removed in wet conditions.

Always ensure that the product data plate remains visible and in good condition, especially the unique serial number.

Ongoing maintenance

It is important to check that the SiteStation is not damaged before every use.

We recommend for you to check the hinges, locks, casters and crane lifting eyes every three months, to ensure that the SiteStation can operate fully. If the SiteStation will be under rigorous outdoor use, we recommend integrity checking regularly.

Always carry out integrity checks before lifting the unit.

Apply light oil to hinges for smoother operation.



Transporting the unit

The design of the SiteStation makes transporting the product easy.

The unit comes as standard with 4-way forklift pockets for transporting using a forklift. Please always take care when moving the SiteStation. The unit comes with heavy-duty casters for easy maneuvering even when fully loaded.

It is always advised to lift the unit using the crane lifting eyes only when the SiteStation is empty of its contents.

All locks on the SiteStation should be secured and keys removed and put in a safe place before moving the unit.

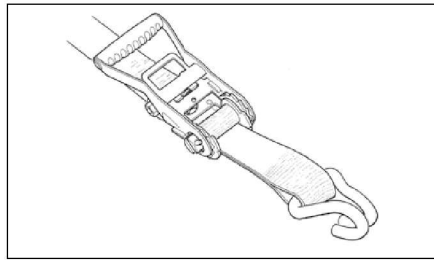
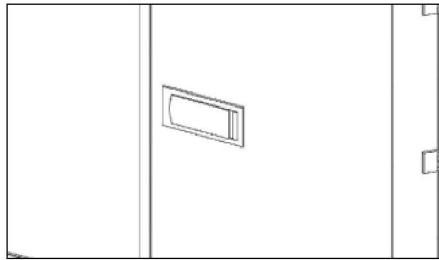

1. Always secure the locks and remove key before lifting the unit, to ensure that the doors do not open unexpectedly.

2. During transportation, ensure the SiteStation is secured using straps or other measures.

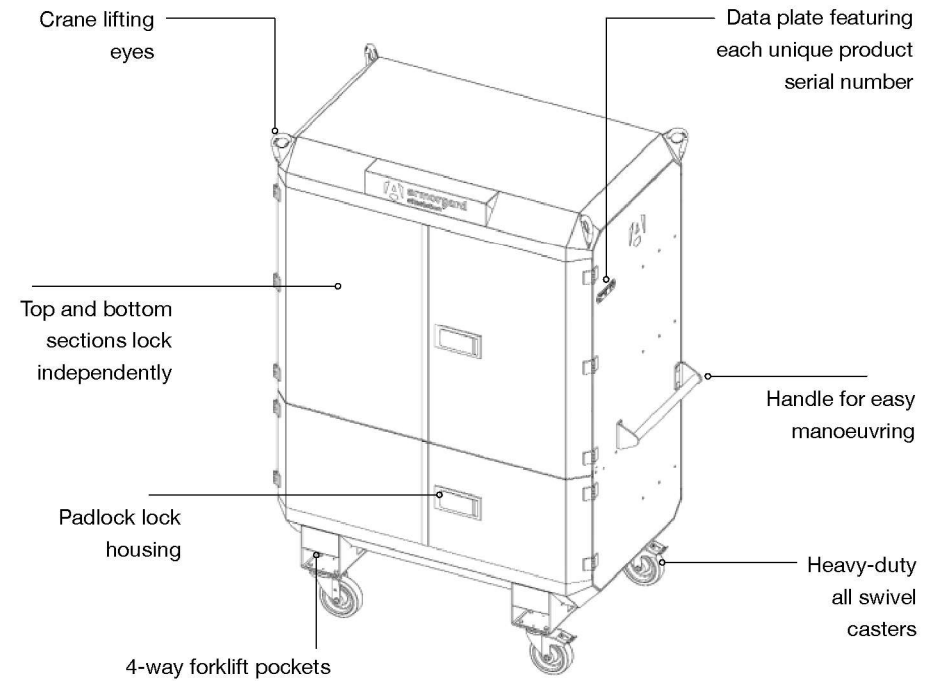

Suitable for use on-site



Product with handles



Cable pass through point



Padlock housing dimensions

This lock system is designed to be used with a Master Lock No. 1, Master Lock No. 5, ABUS 41/50 or American Lock No. 50, or an equivalent sized lock. If you are using a padlock not listed above, it is your responsibility to make sure the lock mechanism is working correctly. Padlocks must meet ALL requirements listed in diagram.

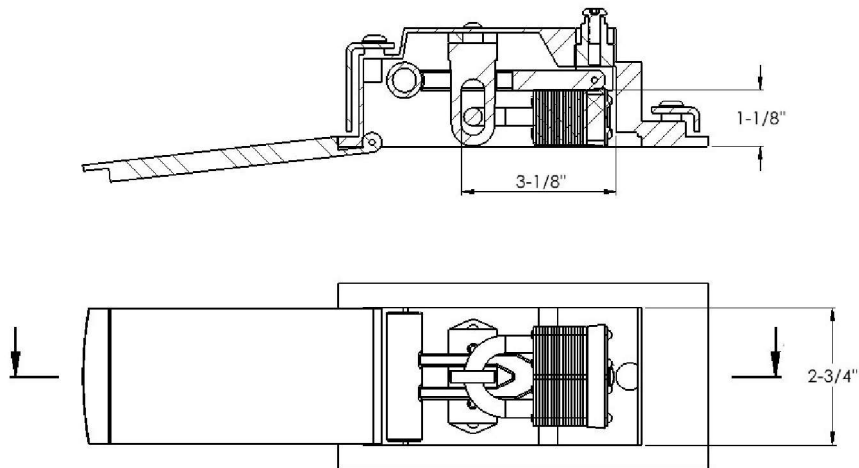

Requires one padlock per door

Padlock not included

Storing the unit

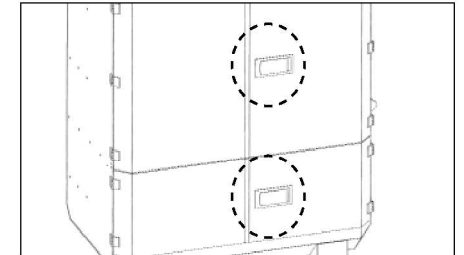

- 1.** Ensure that all SiteStation locks are secured after use, or when leaving the unit unattended. This is essential to maintain the security of the unit.
- 2.** As both top and bottom sections lock independently, ensure that these are both locked.

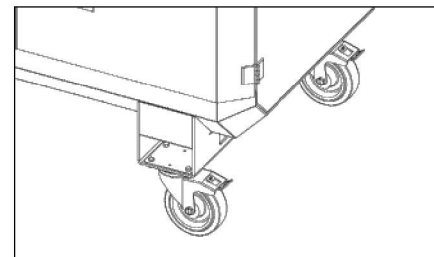

- 3.** When the SiteStation is in position, always ensure the caster brakes are used.

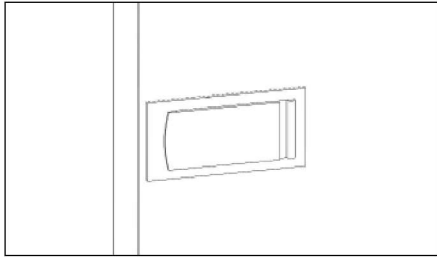

- 5.** To lock the unit, shut both doors, then open the cover plate to expose the locking mechanism.

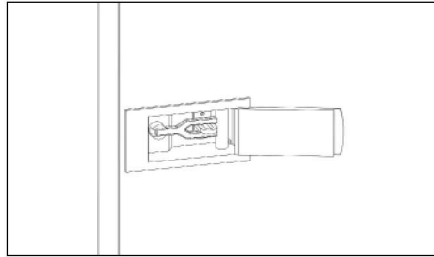

- 6.** Ensure the T Handle is parallel to the front face of the door.

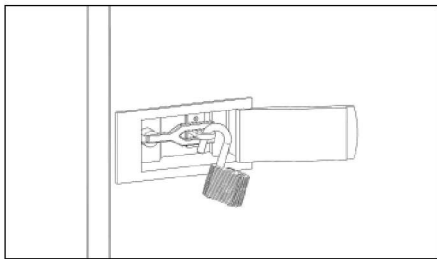

- 7.** Slide an unlocked padlock into the inner shackle of the pocket to prevent the movement of the T Handle.

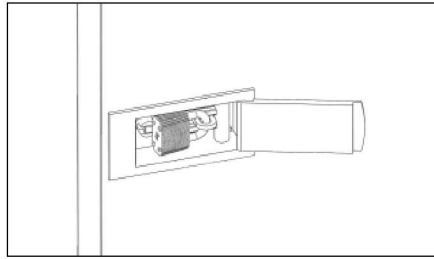

- 8.** Lock the padlock, and fit it into the lock housing. After removing the key, the cover plate should be able to close easily.

How to assemble

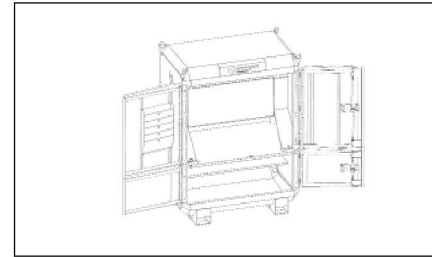

- 1.** It is important to check that the product is not damaged upon arrival and all parts are intact.

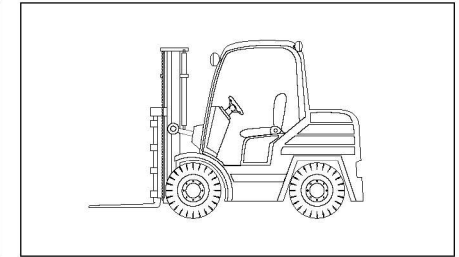

- 2.** You may require a forklift or pallet truck when unloading your SiteStation.



»
Video: how to attach
the casters

Attaching the casters

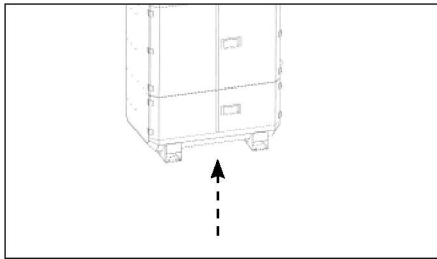

1. Lift the CuttingStation onto a stable platform to ensure it does not roll and cause injury. The unit **MUST** be empty when installing casters.

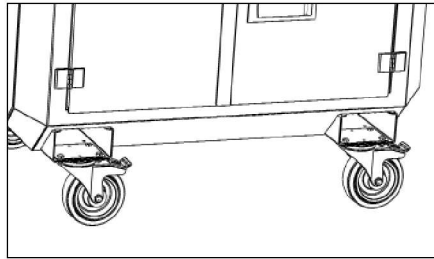

2. Two of the casters are swivel-braked. Fix both braked casters at the front of the unit.

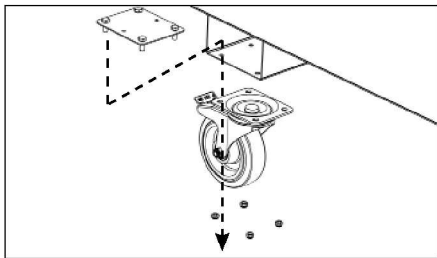

3. Insert the caster plate and tighten the nuts from the bottom using the adjustable wrench. Repeat for all.

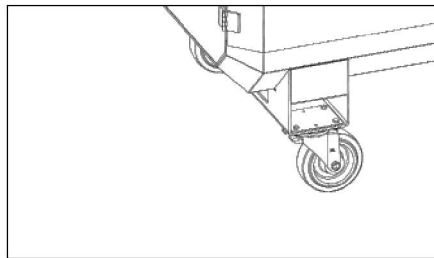

4. Repeat step three for the other wheels. Once complete, check all nuts are tight, and then ensure the casters can swivel 360° before lowering the SiteStation.



»
Video: how to use
T-Latch Lock

How to use the lock

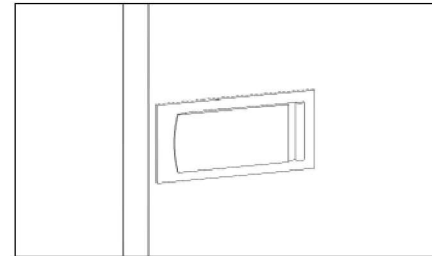

1. To open the unit, locate the lock housing at the center of the door. Open the cover plate to expose the locking mechanism.

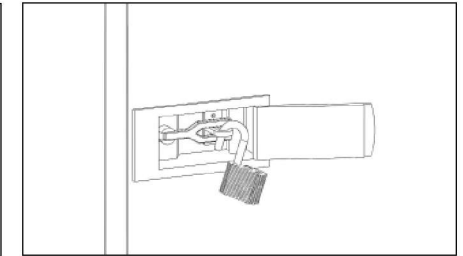

2. Unlock the padlock and remove it.

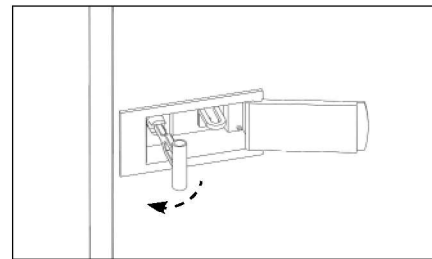

3. Grab the T-Handle and swing it to the left until it's perpendicular to the front face of the door.

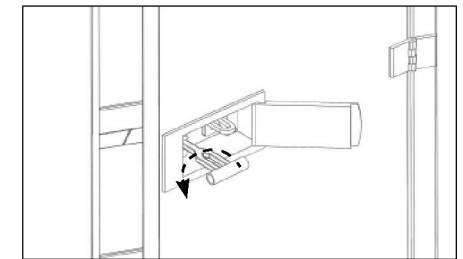

4. Twist the handle 90° to release the door and pull it to open it.



How to use

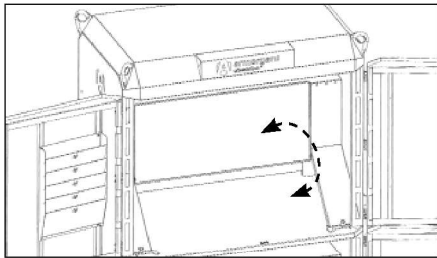

- 1.** The folding shelf can be lowered to create a lockable compartment, or raised to access the space behind. Ensure the folding shelf is secured when in the open position, using the built-in slide and latch system. Always be careful of finger trap points.

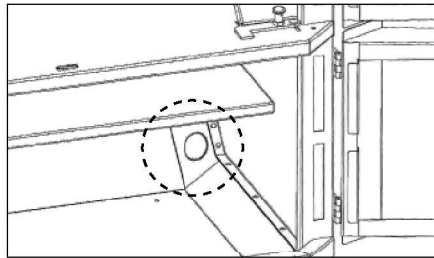

- 2.** The lower storage area features a cable pass-through hole that can be used to feed a power strip cable inside. We recommend using a plastic cable pass-through.

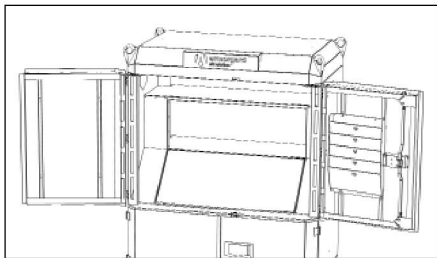

- 3.** On both inner sides of the unit, use the curved door stays to keep the doors held open to avoid them closing unexpectedly.



»
Video: how to attach
the handle

Attaching the handle

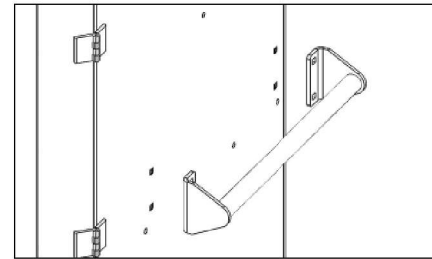

- 1.** Locate the pre-drilled holes on the sides of the unit. Take the handle and align the unit holes with the ones in the handle plates.

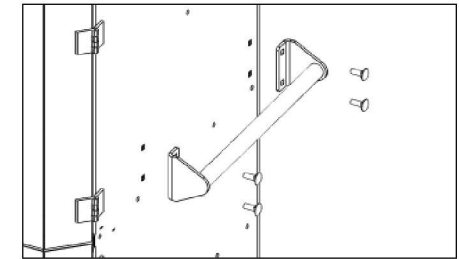

- 2.** Place the coach bolts in them. You may require someone to hold the coach bolt in position until it is fixed from the inside of the SiteStation.

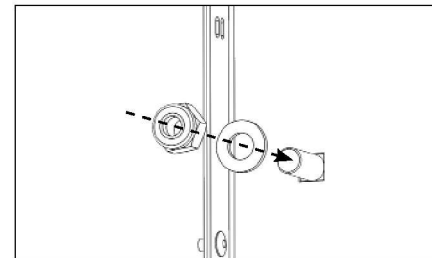

- 3.** Open the unit doors. From the inside of the cabinet, insert the washers and nuts into the coach bolts and tighten fully.

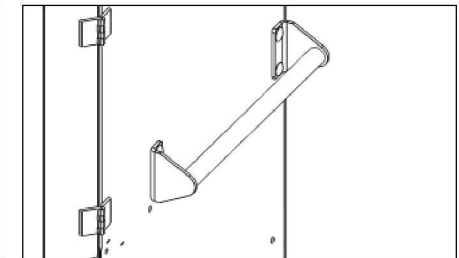

- 4.** Ensure the handle is attached on tightly before using it.



»
Video: how to install
the rubber grommet

Installing the rubber grommet

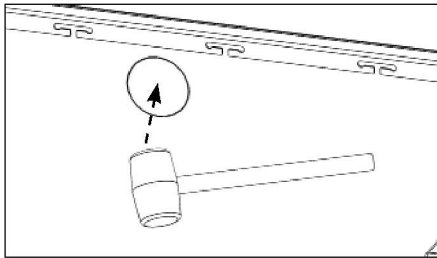

1. Locate the cut-out plate at the back of the body of the unit. With the help of a rubber mallet, carefully knock the cut-out plate from the inside.

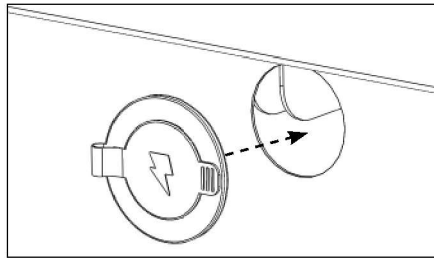

2. Next, take the rubber grommet and place it from the outside to fit the cut-out. Ensure it is properly installed and no sharp edges are exposed.

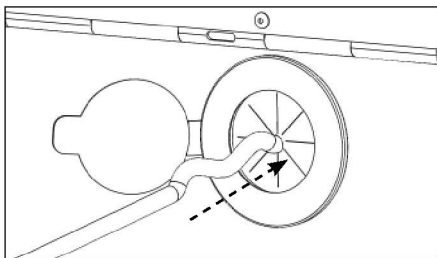

3. When passing cords through the grommet, insert them from the outside.

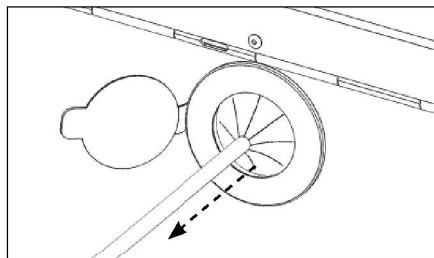

4. After inserting, pull 2-3" of the cord back to make sure rubber fins are pointing out the box.

Electrical safety information

All electrical work **MUST** be performed properly with safety precautions. To prevent injury or damage to property, please ensure the below information is read carefully. Only use UL or CSA listed electrical devices that meet the requirements of the local jurisdiction.

Extension cords

- » Ensure that manufacturer's instructions and safety information are always followed.
- » Never use a damaged cord. Always check before using.
- » Always insert cords after the rubber grommet is safely in place.
- » You must not overload the extension cord.
- » You must only use cords that are designed for outdoor use.
- » When transporting the unit, ensure that all cords have been removed from the grommet.
- » Extension cords must not be connected to outlet that also supplies critical safety equipment.

Cordless battery chargers

- » Ensure that manufacturer's instructions and safety information are always followed. Chargers and batteries must be cared for properly following manufacturer's guidelines.
- » Place electrical components on shelf (if applicable).
- » If electrical components become wet or exposed to hazardous and flammable substances, switch off and discontinue use immediately.
- » Always check chargers and batteries will operate properly and are not damaged.
- » Do NOT come into contact with metal prongs when plugging or unplugging electrical components.
- » Electrical components must be kept away from flammable and hazardous substances.
- » Only place suitable jobsite equipment in the unit.